

# SIRUBA

電控參數說明書

ELECTRONIC CONTROL PARAMETER MANUAL

C007KD/F007KD(CE)  
C007KD/F007KD(CCC)



# EC - Manufacturer Declaration

We declare herewith that the following equipment :

NEEDLE POSITIONER

AC SERVO MOTOR--- TD SERIES

. is designed to be a driver of a sewing unit or system and must not be put into commission until the sewing unit or system has been declared in conformity with the provision of the EC Machinery Directives.

. complies with the following relevant provisions:

- EC Low Voltage Directive (2014/35/EU)
- EC Electromagnetic Compatibility Directive (2014/30/EU)
- EC Machinery Directive (2006/42/EC)

Applied harmonized standards, especially :

**EN ISO 12100:2100**-Safety of machines. General principles for design / Risk Assessment and Risk reduction.

**EN 60204-1:2006/AC:2010** - Safety of machinery-Electrical equipment of machines.

Part1:General requirements.

**EN 60204-31:2013** / Safety of machinery - Electrical equipment of machines.

Part 31: Particular safety and EMC requirements for sewing machines, units and systems.

# 有毒物質限量指令自我宣告書

## Declaration of Conformity for Concentration Limits for Certain Hazardous Substances

本公司所生產之伺服馬達產品系列如下所列：

We declare herewith that the following AC servo motor series products list below：

**AC 伺服馬達--- i 系列/ G 系列/ GD 系列/ MD 系列 / TD 系列**

**AC Servo Motor --- i Series / G Series / GD Series / MD Series/ TD Series**

**Device---TK Series / TC Series / MK Series / MC Series**

皆符合以下指令及要求：

Are complies with the following directives and requirements:

1. 歐盟 RoHS 指令 (2011/65/EU) 及有毒物質的限量要求 ((EU)2015/863)
2. 中華人民共和國電子行業標準：電子信息產品中有毒有害物質的限量要求 (SJ/T 11363-2006)

1. European Union RoHS Directive (2011/65/EU) and the concentration limits for certain hazardous substances ((EU)2015/863).
2. People's Republic of China Electronic Business Standard : Requirements for concentration limits for certain hazardous substances in electronic information products (SJ/T 11363-2006).

本公司產品本身(馬達,控制箱)或其包裝材料及附件(紙箱,螺絲配件包,說明書,貼紙,標籤,印刷品...等等)或其元件與原材料供應商皆依照歐盟 RoHS 指令及中華人民共和國電子行業標準的限量規定而符合以下所列之十種有毒物質的限量要求：

Our product itself (motor, control box) or its packing materials and accessories (box, screws package, user manual, sticker, label, print...etc.) or the suppliers of parts and raw materials are all in conformity with the provision of the European Union RoHS Directive and People's Republic of China Electronic Business Standard to conform the following concentration limits for the ten hazardous substances：

有毒物質 / Hazardous Substance	限量要求 / Permissible Values
鉛 Lead (Pb)	低於 1000 ppm / Less than 1000 ppm
汞 Mercury (Hg)	低於 1000 ppm / Less than 1000 ppm
鎘 Cadmium (Cd)	低於 100 ppm / Less than 100 ppm
六價鉻 Hexavalent chromium (Cr VI)	低於 1000 ppm / Less than 1000 ppm
多溴聯苯 Polybrominated Biphenyl (PBB)	低於 1000 ppm / Less than 1000 ppm
多溴二苯醚 Polybrominated Diphenyl ether (PBDE)	低於 1000 ppm / Less than 1000 ppm
鄰苯二甲酸二酯 Di(2-ethylhexyl)phthalate (DEHP)	低於 1000 ppm / Less than 1000 ppm
鄰苯二甲酸丁酯苯甲酯 Butyl Benzyl Phthalate (BBP)	低於 1000 ppm / Less than 1000 ppm
鄰苯二甲酸二丁酯 Dibutyl phthalate (DBP)	低於 1000 ppm / Less than 1000 ppm
鄰苯二甲酸二異丁酯 Diisobutyl phthalate (DIBP)	低於 1000 ppm / Less than 1000 ppm

- \* 基板的無鉛製程：總鉛含有濃度基準量 800 ppm 以下。
- \* The concentration of lead in the lead-free process for PCB shall be less than 800 ppm.
- \* 包裝材料：Pb+Hg+Cd+Cr VI 含有濃度基準總共合計 80 ppm 以下。
- \* For packing materials shipped with our products or parts, the hazardous substances shall be 80 ppm or less in sum of Pb+Hg+Cd+Cr VI.

# 型 式： TD 300 系列

## 目 次

	頁次
<b>1.安全上的注意事項</b>	
1.1 作業環境的安全	1
1.2 安裝的安全	1
1.3 操作中的安全	2
1.4 保養維修的安全	2
1.5 保養維修的規定	2
1.6 危險標示、注意標示	2
1.7 保固期限規定	2
<b>2.安裝與調整</b>	
(1). 馬達的安裝	3
(2). 控制箱的安裝	3
(3). 控速器的安裝	3
(4). 控速器前、後踏力量調整	3
<b>3.接線與接地</b>	
(1). 電源線的接法	4
(2). 當電源系統配置為三相四線式 380 V，欲使用單相 220 V 供應伺服電機時的接線方式	4
(3). 當單相 220 V 伺服電機欲使用在三相 220 V 的電壓時，須注意配置使用上的負載平衡	5
(4). 如何變換電磁閥 (Solenoid) 的供應電壓( DC : 24 V 或 30 V )	5
<b>4.控制箱各部位名稱</b>	
(1). 控制箱正面	6
(2). 控制箱背面	6
<b>5.LED 字幕畫面的顯示模式</b>	
(1). 在【一般模式】畫面區，面板按鍵的功能與定義	7
(2). 如何進入第一階【參數模式 A】畫面區的操作步驟	7
(3). 如何進入第二階【參數模式 B】畫面區的操作步驟	8
(4). 在【參數模式 A 與 B】畫面區時，面板按鍵的功能與定義	9
(5). 如何進入『參數內容區』進行調整設定	9
<b>6.常用參數內容表</b>	11

## 1.安全上的注意事項：

使用前請詳細閱讀本技術資料與所搭配的縫製機械說明書，配合正確使用，並須由接受過正確訓練的人員來安裝或操作。

在使用或安裝 TD 型伺服馬達系列控制箱驅動裝置時，請注意下列事項。  
本驅動裝置僅適用於指定範圍的縫製機械，請勿移做其他用途。

### 1.1 作業環境的安全：

#### (1).電源電壓：

電源電壓請遵照控制箱銘牌所標示之規格  $\pm 10\%$  範圍內操作。

#### (2).電磁波干擾：

請遠離高週磁波機器或電波發射器等，以免所產生的電磁波干擾本驅動裝置因而發生錯誤動作。

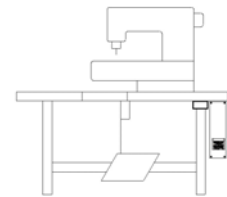
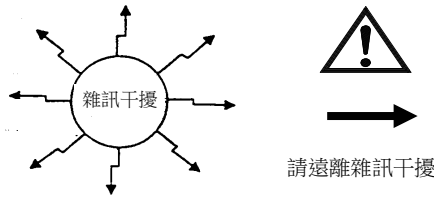

#### (3).溫濕度：

- 請不要在室溫  $45^{\circ}\text{C}$  以上或  $5^{\circ}\text{C}$  以下的場所操作。
- 請不要在日光直接照射的場所或室外運作。
- 請不要在暖氣 (電熱器) 旁運作。
- 請不要在相對濕度  $30\%$  以下或  $95\%$  以上或有露水的場所運作。

#### (4).空氣：

- 請不要在多灰塵或具有腐蝕性物質的場所操作。
- 請不要在有揮發性氣體的場所操作。

### 1.2 安裝的安全：

(1).馬達、控制箱：請遵照說明書正確裝好。

(2).附屬品：如要裝配其它選購配件或附屬品時，請先關閉電源並拔掉電源線插頭。

#### (3).電源線：

- 請注意不要被外物壓住或過度扭曲電源線。
- 裝釘電源線時請不要靠近會轉動的皮帶輪及三角皮帶，最少要離開 3 公分以上。
- 當連接電源線到電源插座時，應確定此供應電壓必須符合標示在控制箱銘牌上的指定電壓  $\pm 10\%$  內。

※注意：控制箱電源系統為 AC 220V 時，請勿插接到 AC 380V 的電源插座上，否則將出現錯誤碼 **E-0. 4** 此時請立即關閉電源開關，重新檢查電源。持續供應 380V 超過五分鐘以上，將會燒毀基板而危及人身安全。



#### (4).接地：

a.為防止雜訊干擾或漏電事故，請做好接地工程。(包括縫紉機、馬達、控制箱、定位器)

單相接線  
(AC110V/220V)

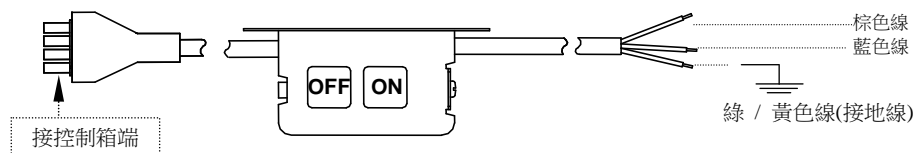

b. 電源線的接地線須以適當大小的導線和接頭連接到生產工廠的系統地線，此連接必須被永久固定。

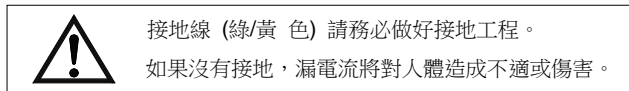

### 1.3 操作中的安全：

- (1). 在第一次開電後，請先以低速操作縫紉機並檢查轉動方向是否正確。
- (2). 縫紉機運轉時，請不要去觸摸皮帶輪、三角皮帶、天枰、針等會作動的部位。
- (3). 所有可作動的部份，必須以所提供的防護裝置加以隔離，防止身體接觸並請勿在裝置內塞入其他物品。
- (4). 請不要在拆下皮帶護蓋及其他安全裝置的情形下操作。

### 1.4 保養維修的安全：

在操作以下動作前，請先關閉電源：

- (1). 要拆卸馬達或控制箱時，或在控制箱上插或拔任何連接插頭時。
- (2). 控制箱裡面有危險高壓電，所以關閉電源後要等 5 分鐘以上方可打開控制箱蓋。

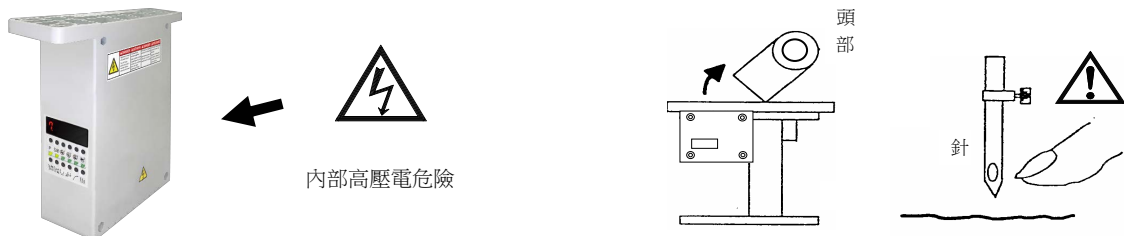

- (3). 翻抬車頭時，與更換車針或梭子或穿線時。(如上圖示)
- (4). 修理或作任何機械上的調整時。
- (5). 機器休息不用時。

### 1.5 保養維修的規定：

- (1). 修理及保養的作業，要請經過訓練的技術人員執行。
- (2). 馬達的通風口附近，請不要堆置雜物阻塞空氣流通，尤其馬達後風蓋上更不可附著灰塵、紙屑、布屑等物，以免造成馬達發燙。
- (3). 請不要以不適當物體，如木槌、鐵槌 .....等敲擊本產品裝置或馬達(電機)心軸。
- (4). 所有維修用的零件，須由本公司提供或認可，方可使用。

### 1.6 危險標示、注意標示

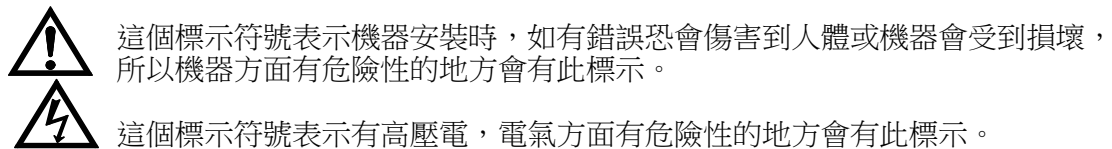

### 1.7 保固期限規定：

本裝置保證在正常工作情況且無人為失誤的操作下，保證出廠 18 個月內，無償的為客戶維修使能正常操作。

## 2. 安裝與調整

### (1).馬達的安裝：

M1 直驅型: (馬達與車頭結合或懸掛在一起的安裝方式) 請參閱各車頭製造廠之說明書。

### (2).控制箱的安裝：

a).車板右側面須預留 100 mm 以上空間

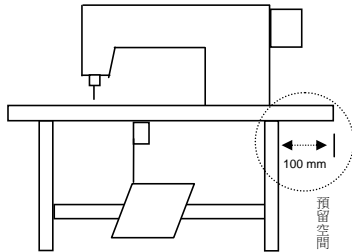

b).將 TD 控制箱鎖裝於車板下方  
尺寸圖

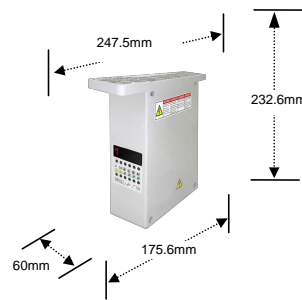

c).安裝後示意圖

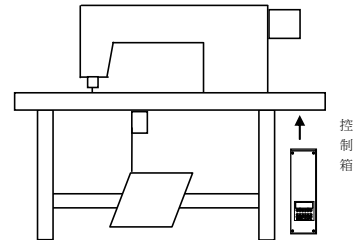

### (3).控速器的安裝：

a.將控速器連座鎖於車板下方

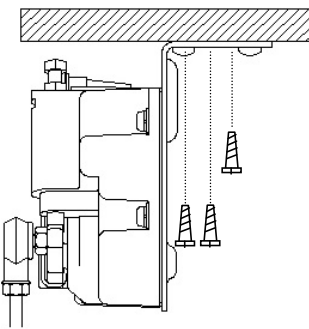

b.安裝後示意圖

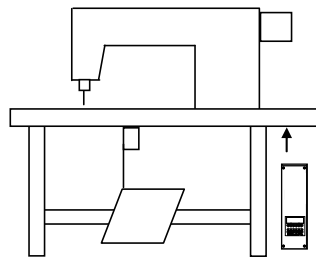

### (4).控速器前、後踏力量的調整：

控速器各部位名稱：如下列圖示

- A：前踏力量彈簧。
- B：後踏力量的調整螺栓。
- C：踏板旋臂。
- D：腳踏板吊桿。

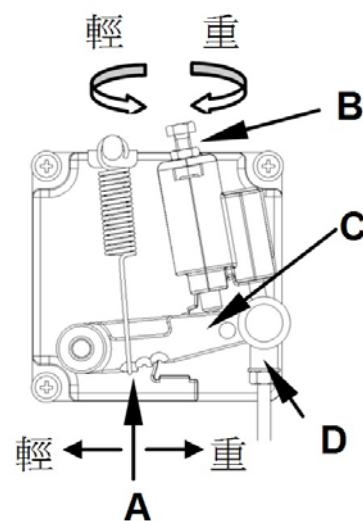

調整需求		調整結果
1	踏板前踏力量的調整	當彈簧 A 愈向右側勾時，表示力量愈重。 當彈簧 A 愈向左側勾時，表示力量愈輕。
2	踏板後踏力量的調整	當螺栓 B 愈向上 ↶ 時，則後踏力量愈輕。 當螺栓 B 愈向下 ↷ 時，則後踏力量愈重。
3	踏板行程長短的調整	當吊桿 D 向右側孔鎖裝時，表示行程較長。 當吊桿 D 向左側孔鎖裝時，表示行程較短。

### 3. 接線與接地：

#### (1).單相與三相電源線的接法：

綠/黃色電線為接地線，一定要做好系統的接地工程，請洽合格的電氣工程人員予以施工。



1. 當三相 220 V 的伺服馬達機型，如要接於單相 200 ~ 240 V 的電壓使用時，只要接 棕色線 和 藍色線 即可，但黑色線請用絕緣膠帶確實包好，以免產生漏電現象。
2. 綠/黃色電線為接地線，一定要做好系統的接地工程。

#### (2).當電源系統配置為三相四線式 380V 時，欲使用單相 220 V 供應本電機的接線方式。



注意：如果此配置系統沒有【中性(點)線】時，則單相 220V 的伺服馬達不適合在此場所使用，請向原供應商改訂購本廠牌之三相 380V 的伺服馬達機型。

注意：必須要有中性(點)線的配置

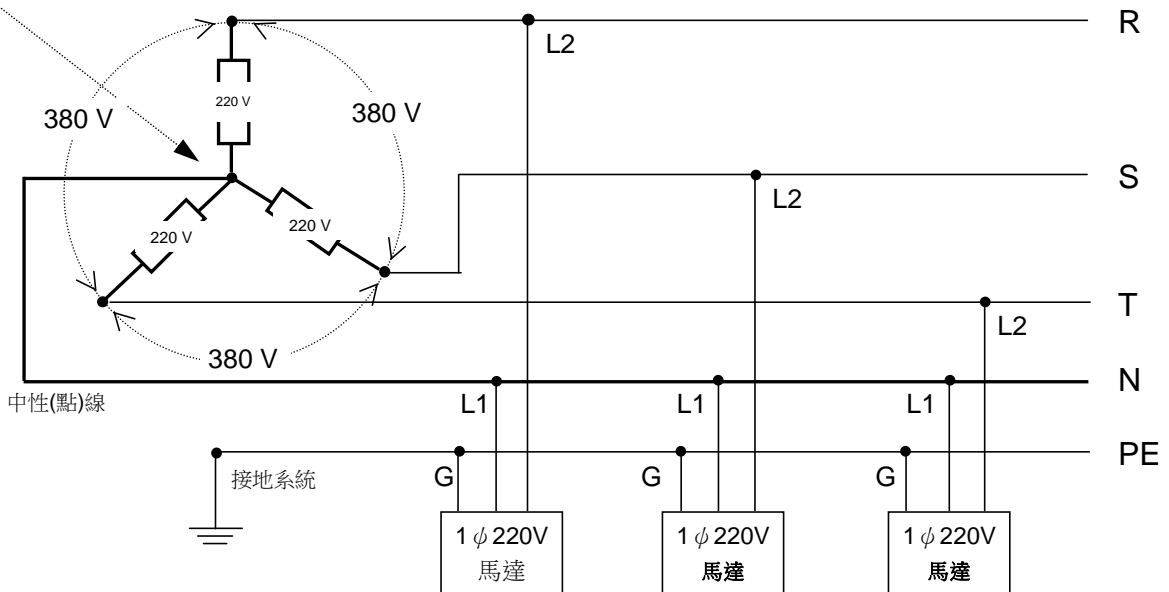



(3).當單相 220 V 伺服馬達欲使用在三相 220V 的電壓時，須注意配置使用上的負載平衡：

連接相當多數量縫紉機配置使用時，需考慮三相中 R、S、T 各相的平衡，如下圖示：

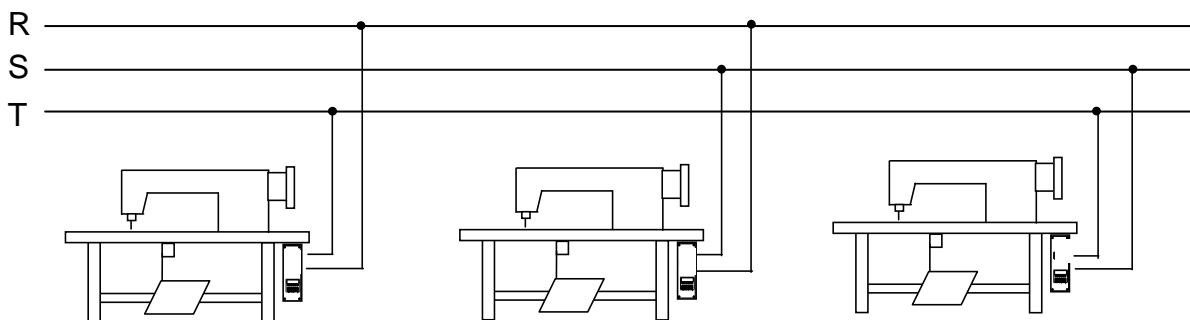

(4).如何變換電磁閥 (Solenoid) 的供應電壓：( DC 24 V 或 30 V )

當電磁閥線圈 (Solenoid) 的使用電壓，如欲由 24 V 改成 30 V 或 30 V 改成 24 V 時，其主基板組的 JP4 插接方式須作適當的變換。

 **注意：** 當欲改變電磁閥線圈(Solenoid)的供應電壓之前，請先確認車頭上電磁閥線圈的使用規格。

 **注意：**  
 在打開控制箱蓋之前，請先將電源關閉  
 約 5 分鐘後，再執行如下插接動作。



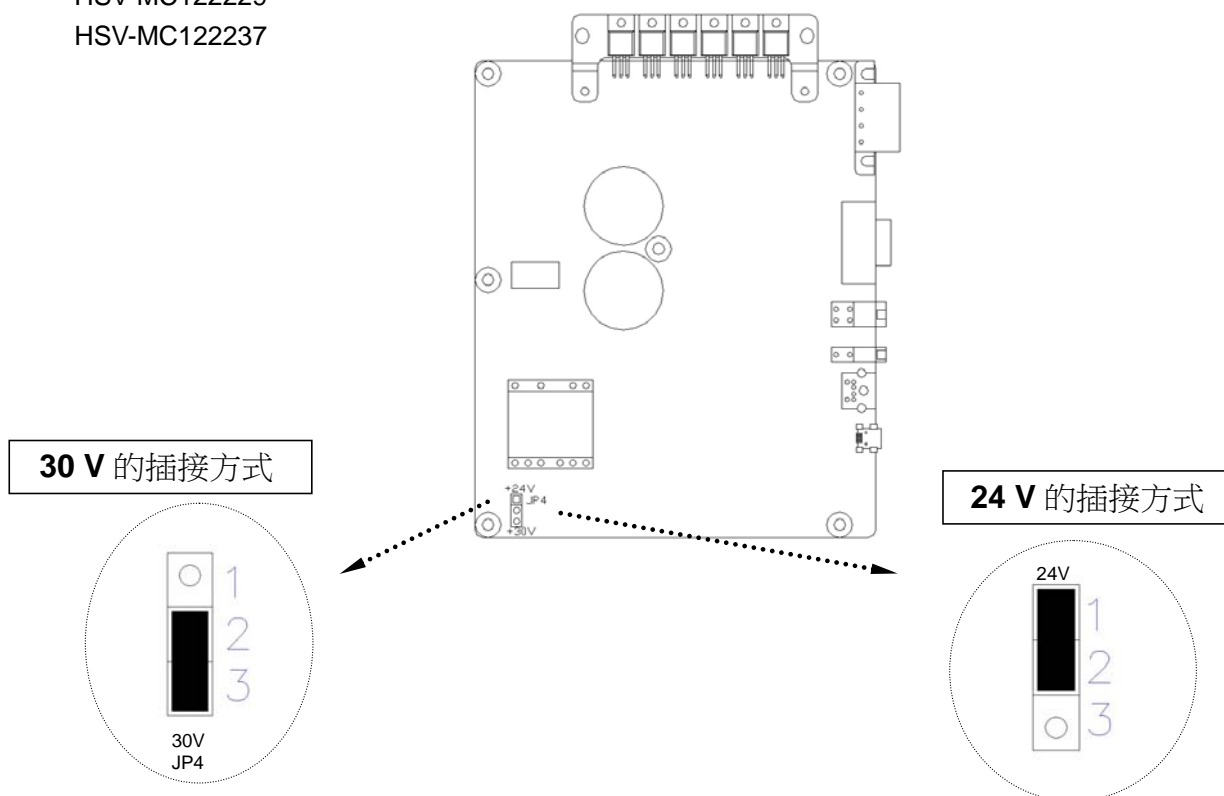

← 內部高壓電危險

主基板組示意圖：  
 HSV-MC122229  
 HSV-MC122237

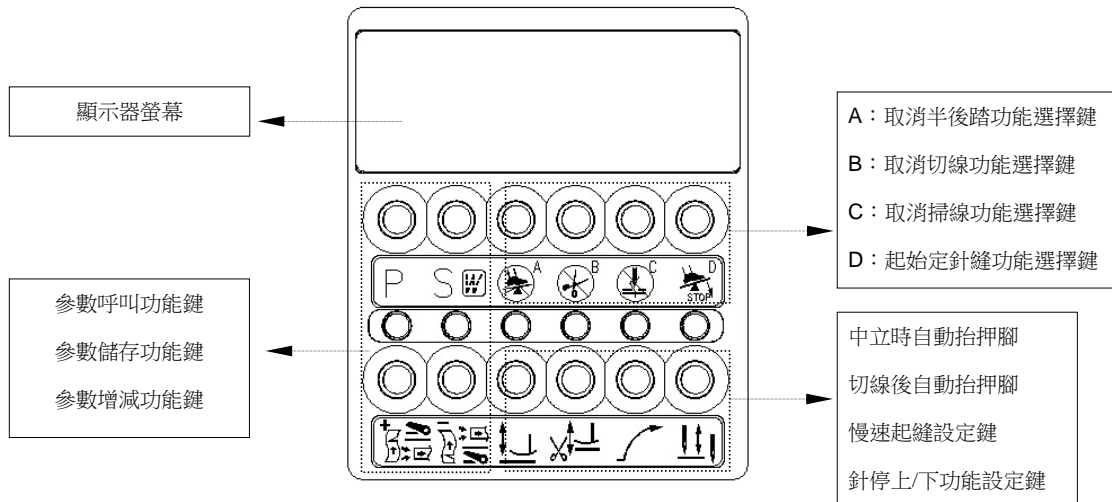

#### 4.控制箱各部位的名稱：

##### (1).控制箱正面：



##### (2).控制箱背面：端子座面板

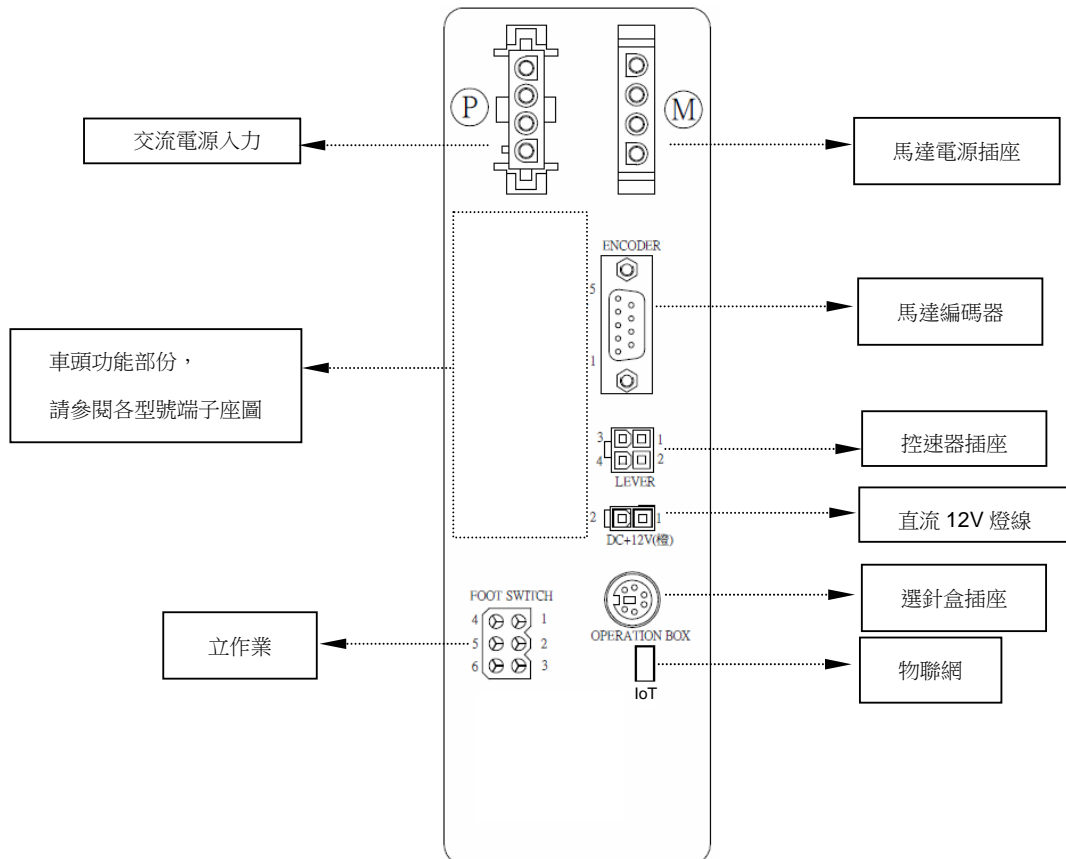

# TD315-6-07-2 端子座圖

## Connector panel diagram

DC+12V LAMP	
1 LED_0V	LED_0V
2 +12V	+12V



SAFETY SW.	
1 +5V	+5V
2 INL	SAFETY SW.
3 0V	0V

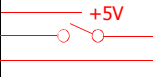

KNEE SW.	
1 INK	KNEE SW.
2 0V	0V

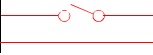

FOOT LIFTER	
1 +24V	+24V
2 OF(8A)	A.F.L. SOL.



SEWING MACHINE	
1 OA(8A)	TRIMMER
2 +24V	+24V
3 +24V	+24V
4 OB(8A)	WIPER
5 OD(1A)	CONDENSED STITCH
6 +24V	+24V
7 OC(8A)	TENSION
8 O1(1A)	OP SOL.
9 +24V	+24V
10 IN1	OP SW.
11 EARTH	EARTH
12 0V	0V

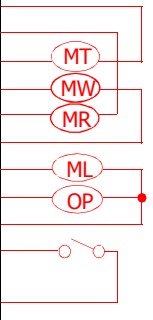

FOOT SWITCH	
1 +12V	+12V
2 ING	START
3 VC	VC1
4 INF	KNEE SW.
5 0V	0V
6 INH	TM SW.

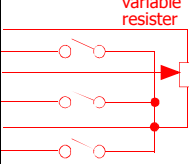

OPTION	
5 O2(1A)	NCL SOL.
10 +24V	+24V
15 O1(1A)	OP SOL.
4 +24V	+24V
9 ---	---
14 +5V	+5V
3 IN2	U SW.
8 ---	PULSE OUT
13 ---	---
2 IN1	OP SW.
7 ---	---
12 0V	0V
1 +12V	+12V
6 INB	PSD
11 0V	0V

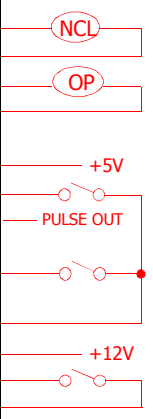
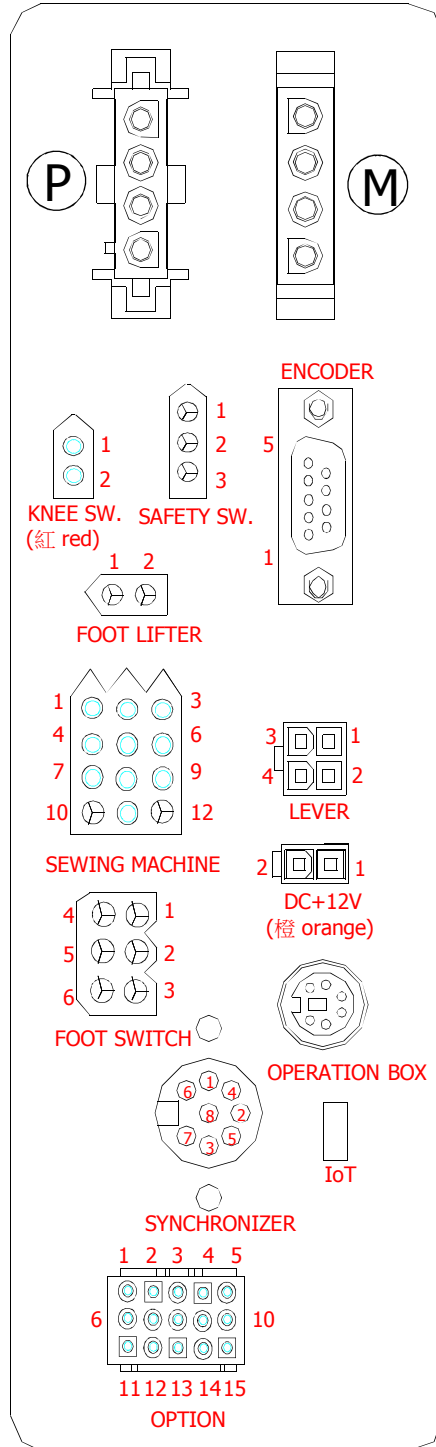
SYNCHRONIZER	
1	---
2	+5V
3	DOWN
4	0V
5	NO SYNC.
6	---
7	UP
8	---

ENCODER	
1	+5V
2	UP
3	DOWN
4	A PHASE
5	B PHASE
6	R
7	S
8	T
9	0V

LEVER	
1	+5V
2	VC
3	KNEE SW.
4	0V

OPERATION BOX	
1	U SW.
2	R1in
3	+12V
4	T1out
5	0V
6	CKU

IoT	
1	+5V
2	T1out
3	R1in
4	---
5	0V

## 5. LED 字幕畫面的顯示模式:

(1). 在【一般模式】畫面區，面板按鍵的功能與定義：

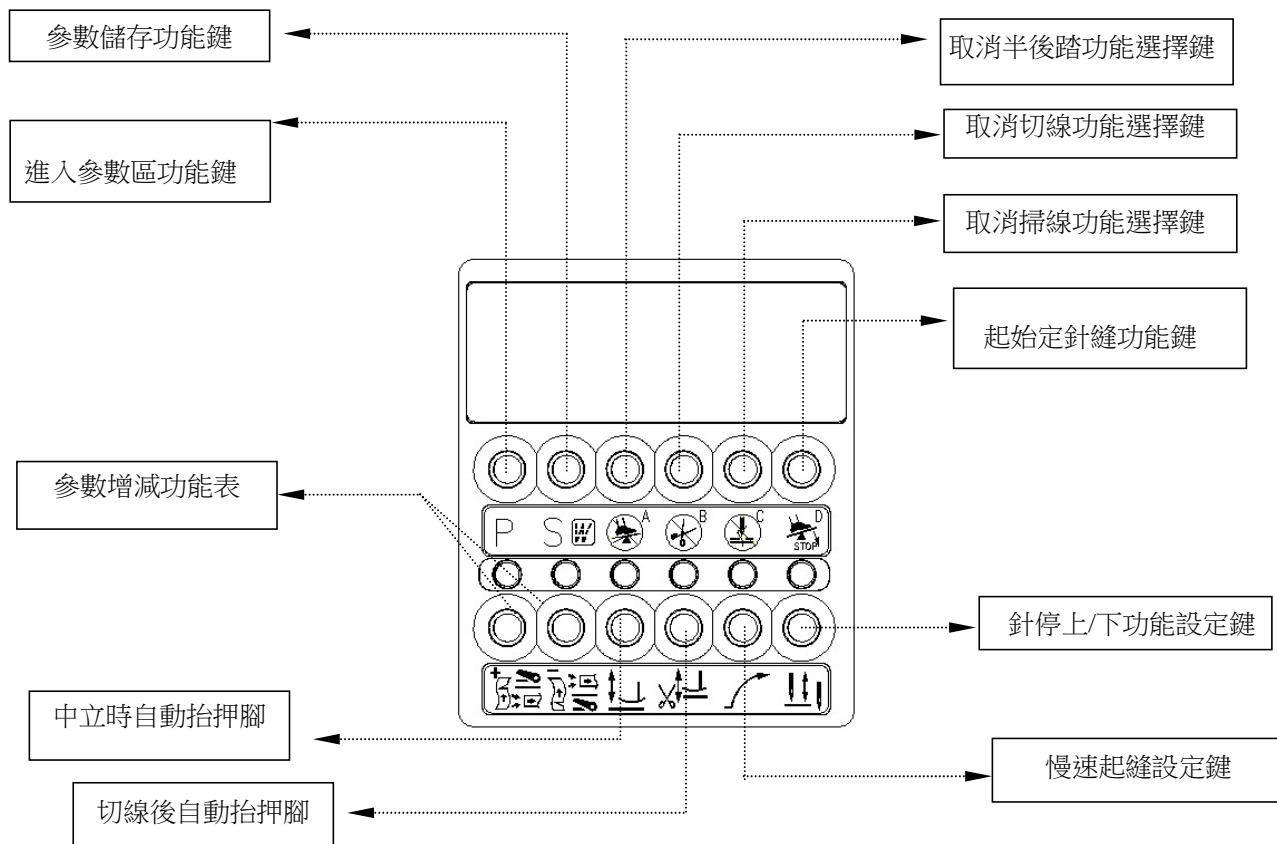

(2). 如何進入第一階【參數模式 A】畫面區的操作步驟：(A 區僅可選參數為：1 ~ 46)

- 在【一般模式】畫面區按一下 **[P]** 鍵，即可進入【參數模式 A】的第一個參數【001.H】的畫面。
- 再以 或 鍵找出欲設定的參數序號，如範例：【002.SLM】
- 按 **[S]** 鍵進入其【內容值】畫面區。
- 進入內容區後再以相對應之 等鍵調整所須之內容值。
- 再按 **[S]** 鍵予以儲存後回至操作區。

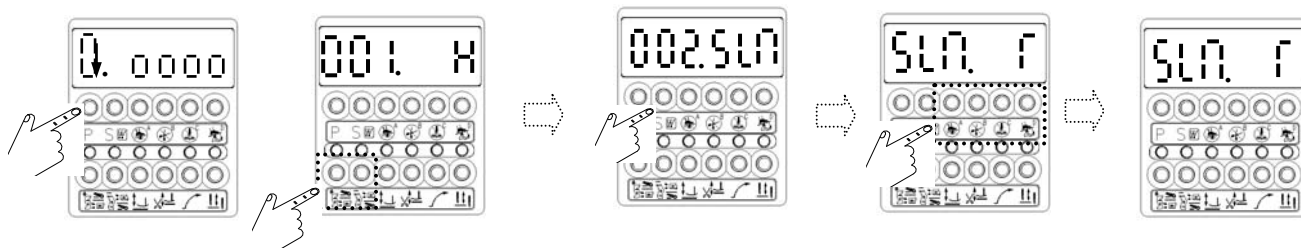

(3).如何進入第二階【參數模式 B】畫面區的操作步驟：(B 區可選參數範圍為：1 ~ 122)

a.如在操作中，請先關閉電源開關

b.以手按住 **P** 鍵，同時開啟電源開關，即進入【參數模式 B】畫面區中的第一個畫面【047.MAC】。

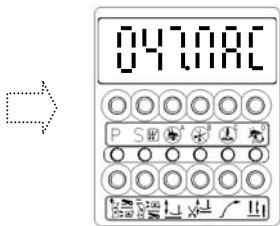
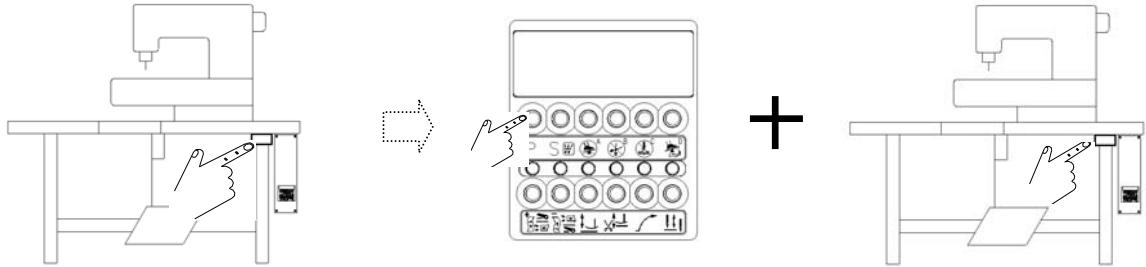

c. 再以 或 鍵找出欲設定的參數序號，如範例：【048.N12】

e. 進入內容區後再以相對應之 等鍵調整所須之內容值。

註 1. 最後按下 **S** 鍵後，即自動回至【一般模式】的操作畫面。  
註 2. 如下範例為：三本車機型模式

d. 以 **S** 鍵進入其【內容值】畫面區。

f. 調整後須按下 **S** 鍵予以儲存確認。

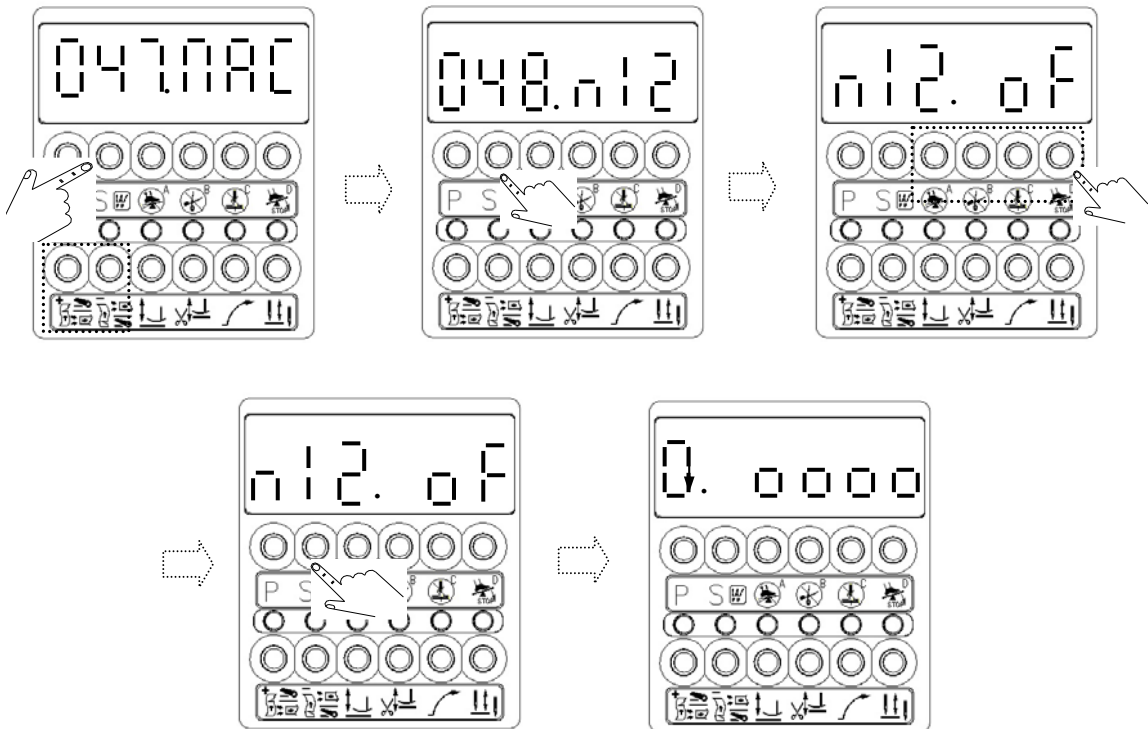

(4).在【參數模式 A 與 B】畫面區時，面板按鍵的功能與定義：（如下範例圖示）

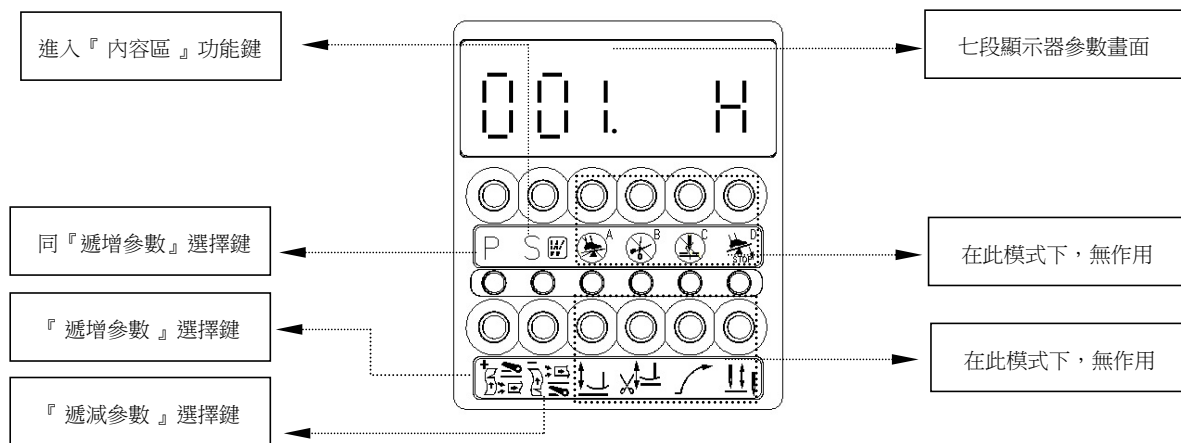

七段顯示器畫面模式

- 進入第一階【參數模式 A】畫面區時，第一個出現畫面為【001. H】，其參數可調範圍為 1 ~ 46 項。
- 進入第二階【參數模式 B】畫面區時，第一個出現畫面為【047. MAC】，其參數可調範圍為 1 ~ 122 項。

(5).如何進入『參數內容區』進行調整設定：

步驟一：先確定欲調整使用的參數代碼。（請參閱參數表或常用參數內容表）

步驟二：依隸屬之參數階級模式，按照其操作步驟進入參數模式區域，並找出欲調整的參數代碼。

（請參閱如何進入各階參數模式的操作步驟）。

步驟三：再進行所需參數內容值的調整：（在功能方面可直接以  $\odot^C$  或  $\otimes^D$  鍵作切換，在速度、時間、角度等方面請參照如下範例調整：例如參數【001. H】內容值的調整）：

A).將內容值或數值，調整比原預設值『還高』時的調整方式：

例如：將出廠預設值【H. 4500】調高至【H. 5000】

請依第 5 章節的 (4) 或 (5) 敘述之 a、b、c 進至『內容區』畫面後，再依如下步驟逐步進行其數值調整設定。

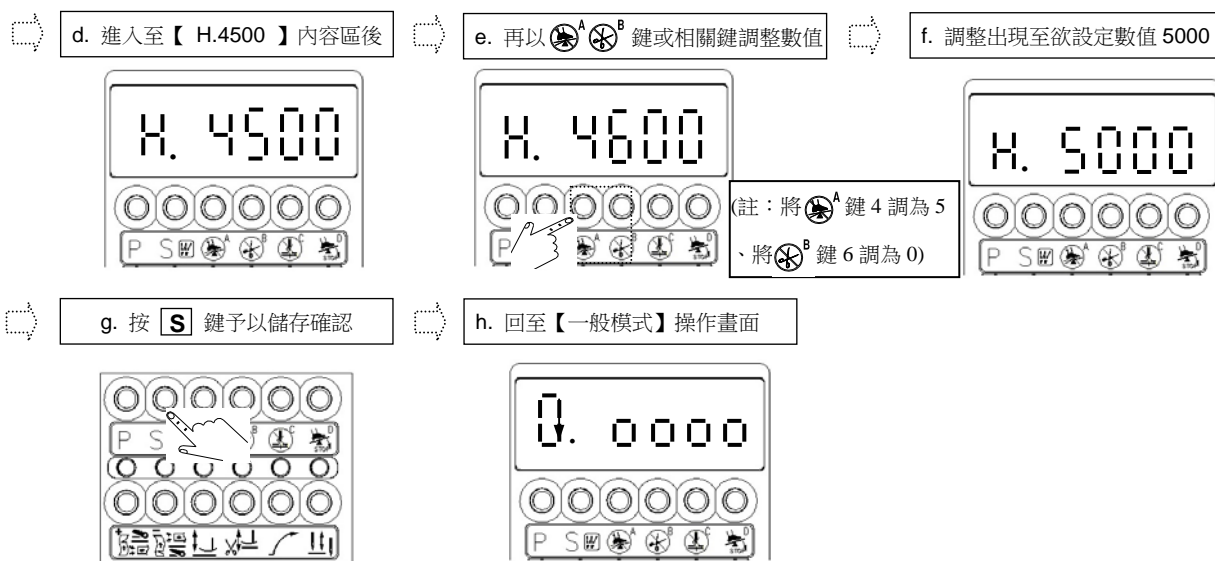

B).將內容值或數值，調整比原預設值『還低』時的調整方式：

例如：將出廠預設值【H. 4500】調低為 4000 轉時：

請依第 5 章節的 (4) 或 (5) 敘述之 a、b、c 進至『內容區』畫面後，再依如下步驟逐步進行其數值調整設定。

d. 進入至內容區，如【H.4500】 e. 連按  鍵，一直遞增數值回歸至 0

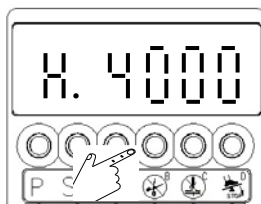
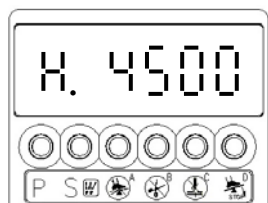

f. 調整至欲設定數值 4000 後 g. 按 **S** 鍵予以儲存確認 h. 回到【一般模式】操作區畫面

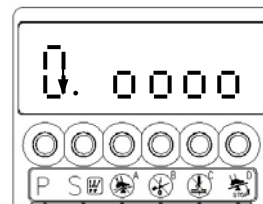
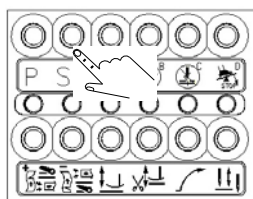
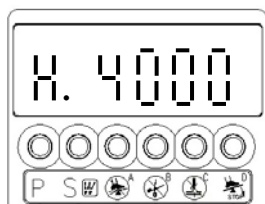

## 6.常用參數內容表：

參數代碼		參數定義	調整範圍
按 P 鍵			
001	H	最高轉速 ( spm )	50-8000 spm
004	N	起始回縫速度 ( spm ) 或 三本車機型的定針縫速度 ( spm )	50-8000 spm
005	V	終止回縫速度 ( spm )	50-8000 spm
006	B	連續回縫速度 ( spm )	50-8000 spm
007	S	慢速起縫速度 ( spm )	50-2000 spm
008	SLS	慢速起縫針數 ( 針 )	0-99 stitches
009	A	自動定針縫速度 ( spm ) 或自動運轉測試時之速度	50-8000 spm
010	ACD	定針縫後自動執行終止回縫選擇 ( 亦是補針功能的『取消』設定 )	ON/OFF
011	RVM	『手按回縫』開關的功能模式選擇	J/B
040	WON	掃線 ( 吹風 ) 功能設定	ON/OFF
041	TM	切線 功能設定	ON/OFF
045	SP	車縫速度顯示	0-8000
046	DIR	馬達運轉方向 ( 面對馬達皮帶輪 )	CW/CCW
按 P 鍵+Power ON			
060	L	低速速度 ( spm )	50-500 spm
061	T	切線速度 ( spm )	50-500 spm
064	FO	押腳全額初始出力的動作時間 ( ms )	0-990 ms
065	FC	押腳出力動作的週期信號 ( % )	10-90%
066	FD	延遲馬達起動，保護押腳放下時間 (ms)	0-990 ms
070	HHC	半後踏時，取消抬壓腳功能	ON/OFF
075	SFM	安全開關信號型式	NC/NO
083	T2	切線動作時間 (ms)	0-990 ms
087	L2	鬆線動作時間 (ms)	0-1500 ms
093	W2	撥 / 掃線 (或吹風) 動作時間 (ms)	0-9990 ms
119	DD	馬達驅動方式	ON/OFF
121	ANU	開電後自動找『針上』位置	ON/OFF
122	HL	車縫最高速度限制	50-9999 spm



# Model : TD 300 series

## Contents

---

	頁次
<b>1. Safety Precaution</b>	
1.1 Work Environment .....	1
1.2 Safety in installation.....	1
1.3 Safety in Operation .....	2
1.4 Safety in Maintenance and repairs.....	2
1.5 Regulation in maintenance and repairs.....	2
1.6 Danger and caution signs .....	2
1.7 Warranty information .....	2
<b>2. Installation and adjustment</b>	
(1). Motor installation.....	3
(2). Control box installation.....	3
(3). Speed control unit installation.....	3
(4). Adjust the speed control unit.....	3
<b>3. Power connection and grounding</b>	
(1). Single phase connection.....	4
(2). How to connect a 1 $\Phi$ / 220 V power from a 3 $\Phi$ / 380 V power source.....	4
(3). The load balance when use a 1 $\Phi$ / 220 V motor used on a 3 $\Phi$ / 220 V power source.....	5
(4). How to change solenoid supply voltage (DC: 24 V OR 30 V) .....	5
<b>4. Diagrams of control box</b>	
(1). Front side .....	6
(2). Rear side .....	6
<b>5. Programmable 7-segment display</b>	
(1). Key functions in the 【Normal Mode】 on a interlock stitch machine.....	7
(2). How to access 【Parameter Mode A】 .....	7
(3). How to access 【Parameter Mode B】 .....	8
(4). Key functions in the Parameter 【Mode A and B】 .....	9
(5). How to access the 【Mode Value】 and adjust the setting.....	9
<b>6. General Parameter Table.....</b>	<b>11</b>

**Appendix** : 7-Segment Display Characters Compare Chart

# 1. Safety Precaution:

**Please read this manual carefully, also with related manual for the machine head before use. For perfect operation and safety, installing and operating this product by trained personnel is required.**

When install and operate TD Servo Motor, precaution must be taken as the following.

This product is designed for specify sewing machines and must not be used for other purposes.

## 1.1 Work Environment:

(1). Power voltage:

Only use Power Voltage indicated on the name plate of the TD in  $\pm 10\%$  ranges.

(2). Electromagnetic pulse interference:

To avoid the false operate, please keep the product away from the high electromagnetic machinery or electro pulse generator.



(3). Temperature:

a. Please don't operate in room temperature is above  $45^{\circ}\text{C}$  or under  $5^{\circ}\text{C}$

b. Avoid operating in direct sun light or outdoors area.

c. Avoid operating near the heater.

d. Avoid operating in the area which humidity is  $30\%$  or less and  $95\%$  or more, also keep away dew area.

(4). Atmosphere:

a. Avoid operating in dusty area, and stay away from corrosive material.

b. Avoid operating in evaporate or combustible gas area.

## 1.2 Safety In Installation:

(1). Motor and control box: Follow the instruction in this manual for correct installation.

(2). Accessories: Turn off the power and unplug the cord before mounting any accessories.

(3). Power cord:

a. Avoid power cord being applied by heavy objects or excessive force, or over bend.

b. Power cord must not set to be near the V-belt and the pulley, keep 3 cm space or above.

c. Check the outlet voltage before plugging the cord, make sure it match the voltage shown on the name plate of the TD in  $\pm 10\%$  ranges.

**⚠ Attention : If the control box is AC 220V system, please don't connect to the AC 380V power outlet, otherwise the error code E\_r0. 4 will occur. If that happened, please turn off the power switch immediately and check the power voltage. Continue supply the 380V power over 5 minutes might damage the main board and even might endanger the person safety.**



(4). Grounding:

- a. To avoid the static interference and current leakage, all grounding must be done.
- b. Use the correct connector and extension wire when connecting ground wire to Earth and secure it tightly.

**Single phase ( AC110V / 220V )**

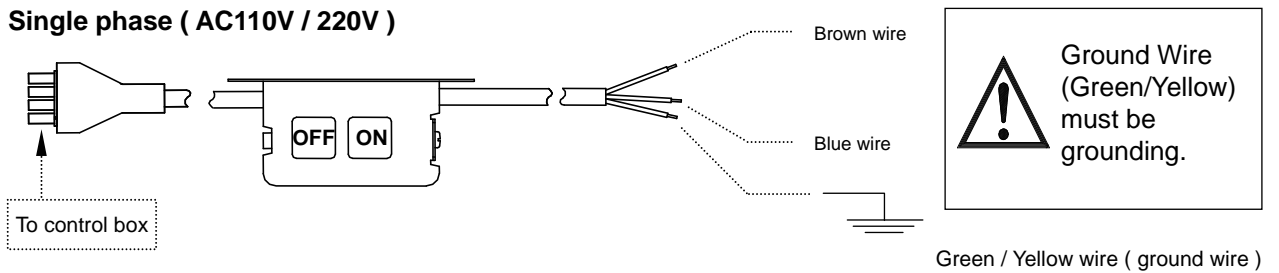

**1.3 Safety In Operating:**

- (1). When turn on the machine in the first time, use low speed to operate and check the correct rotation direction.
- (2). During machine operation, don't touch any moving parts.
- (3). All moving parts must use the protective device to avoid the body contact and objects insertion.

**1.4 Safety in Maintenance and Repairs:**

Power must be turned off first, when:

- (1).Uninstall the motor or the control box, or plug and unplug any connector.
- (2).Turn off the power and wait 5 minutes before opening box cover.

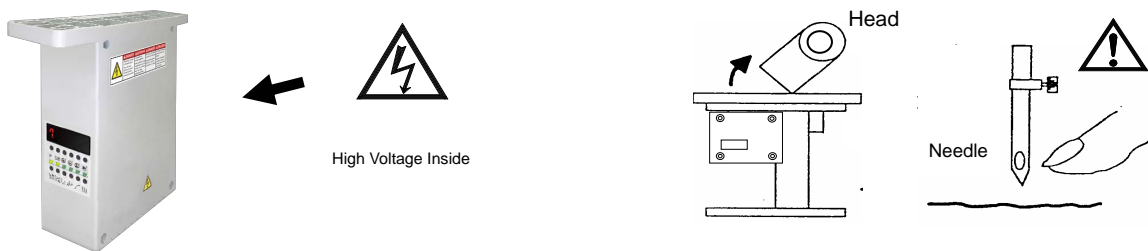

- (3).Raising the machine arms or changing needle, or threading needle.(show as above)
- (4).Repairing or doing any mechanical adjustment.
- (5).Machines rest.

**1.5 Regulation in Maintenance and Repairs:**

- (1).Maintenance and Repairs must be done by specially trained personnel.
- (2).Don't cover up motor's ventilation, it can cause motor over heated.
- (3).Don't use any objects or force to hit or ram the product.
- (4).All spare parts for repair must be approved or supplied by the manufacturer.

**1.6 Danger and Caution Signs:**



Risks that may cause personal injury or risk to the machine are marked with this symbol in the instruction manual.



This symbol indicates electrical risks and warnings.

**1.7 Warranty Information:**

Manufacturer provide a warranty in respect of the products covered for a period of 1 year use or 1 year and 6 months after the shipping date of the products for any defects arising in the normal course of use of the products by customers.

## 2. Installation and Adjustment:

### (1). Motor installation:

When motor and machine installed together, refer to the machine head's instruction.

### (2). Control Box Installation:

a). Leave 100 mm space at right

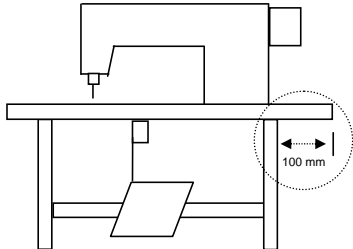

b). Mounting TD under the working table

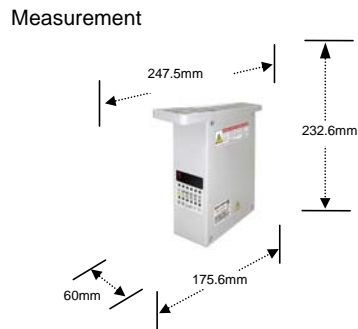

c). Installation layout

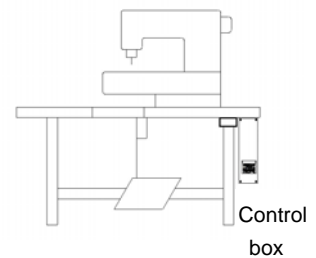

### (3). Speed Control Unit Installation:

a). Keep rod in vertical, secure the unit under the table

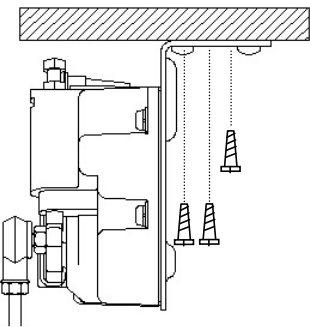

b). Installation layout

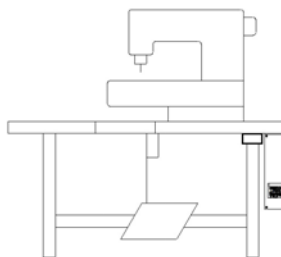

### (4). Adjust the Speed Control Unit:

Components of the speed control unit: see figure

A : Spring for toeing forward force adjustment

B : Bolt for heeling backward force adjustment

C : Treadle / Pedal arm

D : Pitman Rod for Treadle / Pedal

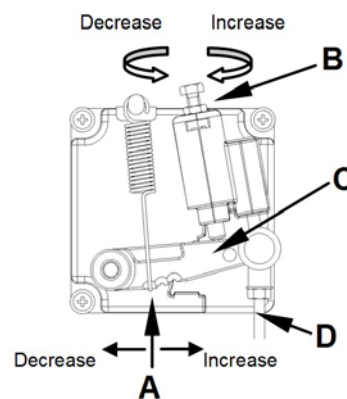

Term of adjustment	Adjustment result
1 Toeing forward force adjustment	Spring A move to right = force increased Spring A move to left = force decreased
2 Heeling backward force adjustment	Bolt B turn ↶ = force decreased Bolt B turn ↷ = force increased
3 Treadle stroke adjustment	Rod D secure at right = stroke is longer Rod D secure at left = stroke is shorter

### 3. Power Connection and Grounding:

(1). Single phase connection:

Green/yellow wire is the ground wire.

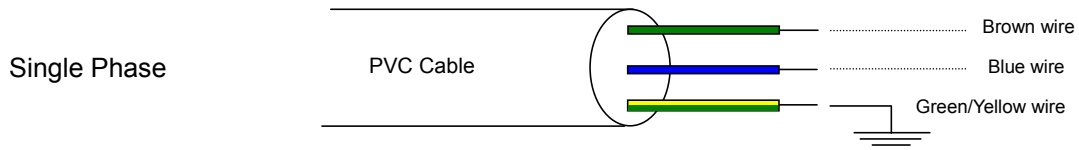

Green / Yellow wire must do the grounding.

(2). How to connect a 1Φ / 220 V power from a 3 Φ / 380 V power source

**Caution :** If the power source does not have the neutral point, then this 1Φ / 220 V servo motor is not suitable for this connection. Please ask supplier to offer our 3Φ / 380 V servo motor.

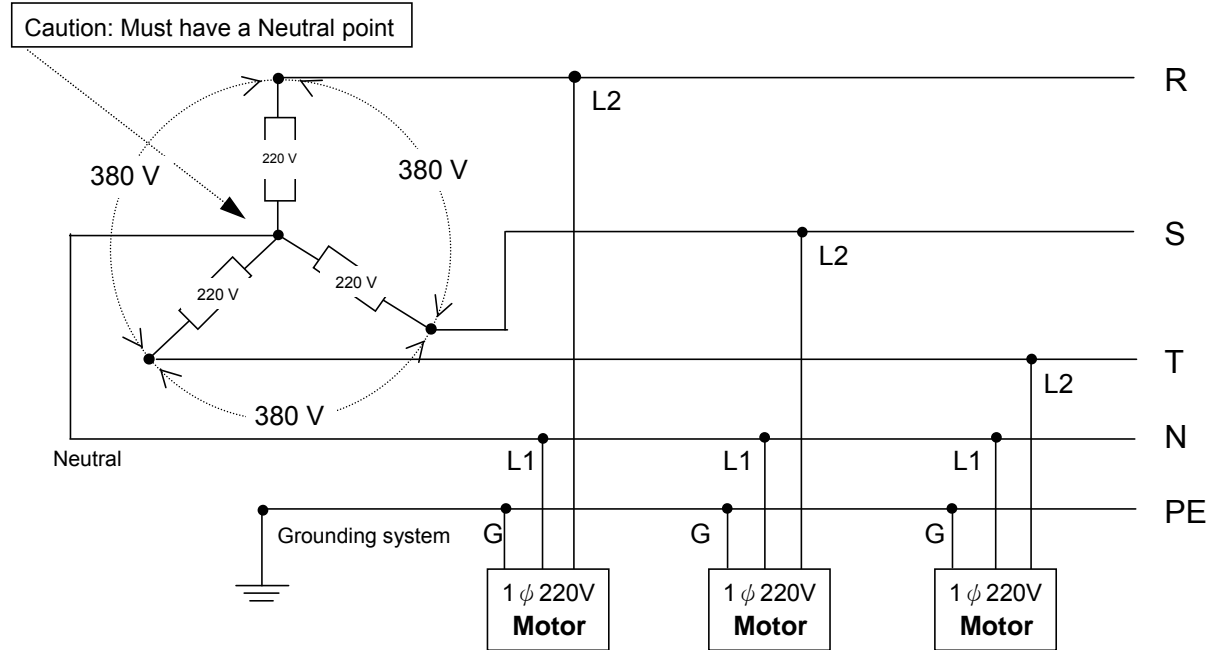

(3). The load balance when use a 1Φ / 220 V motor used on a 3 Φ / 220 V power source.

See the following figure for the load balance.

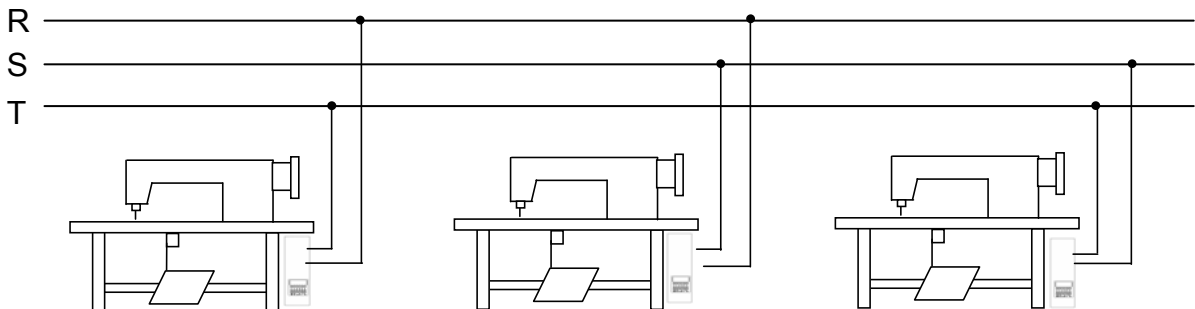

(4). How to change solenoid supply voltage (DC: 24 V OR 30 V) :  
The JP4 is for 30 V and 24 V.

**Caution:** Before making the switch, check the machine head's Solenoid specification.

 **Caution:**  
Turn off the power wait for 5 min. before open the cover, then make the change.



 High Voltage inside

Main board layout:

HSV-MC122229  
HSV-MC122237

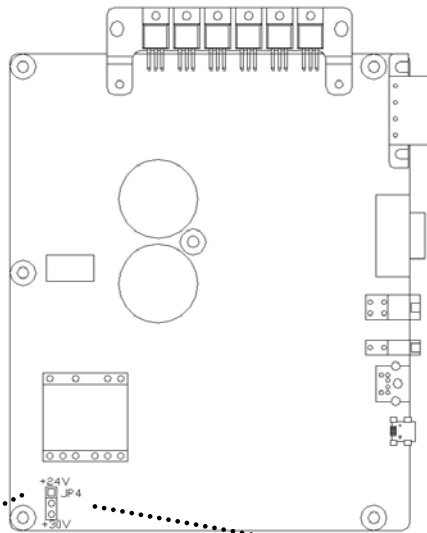

**30 V jumper setting**

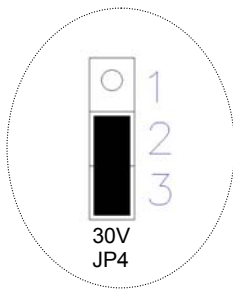

**24 V jumper setting**

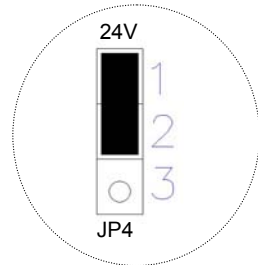

## 4. Diagrams Of Control Box:

(1). Front side:

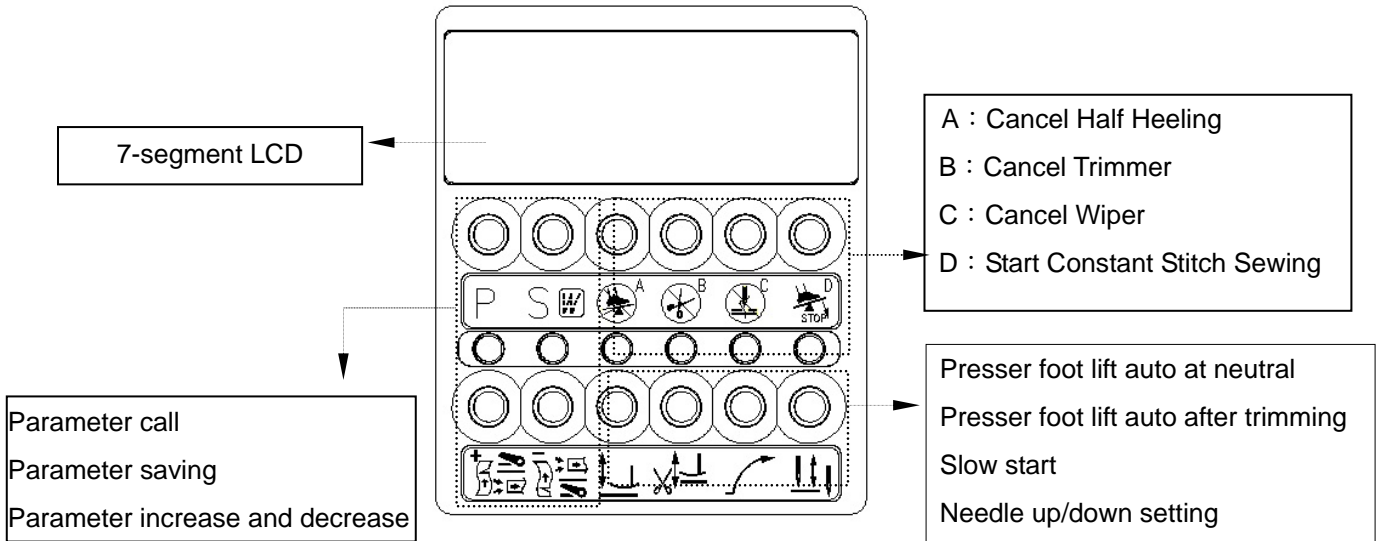

(2). Rear side: Connector Panel

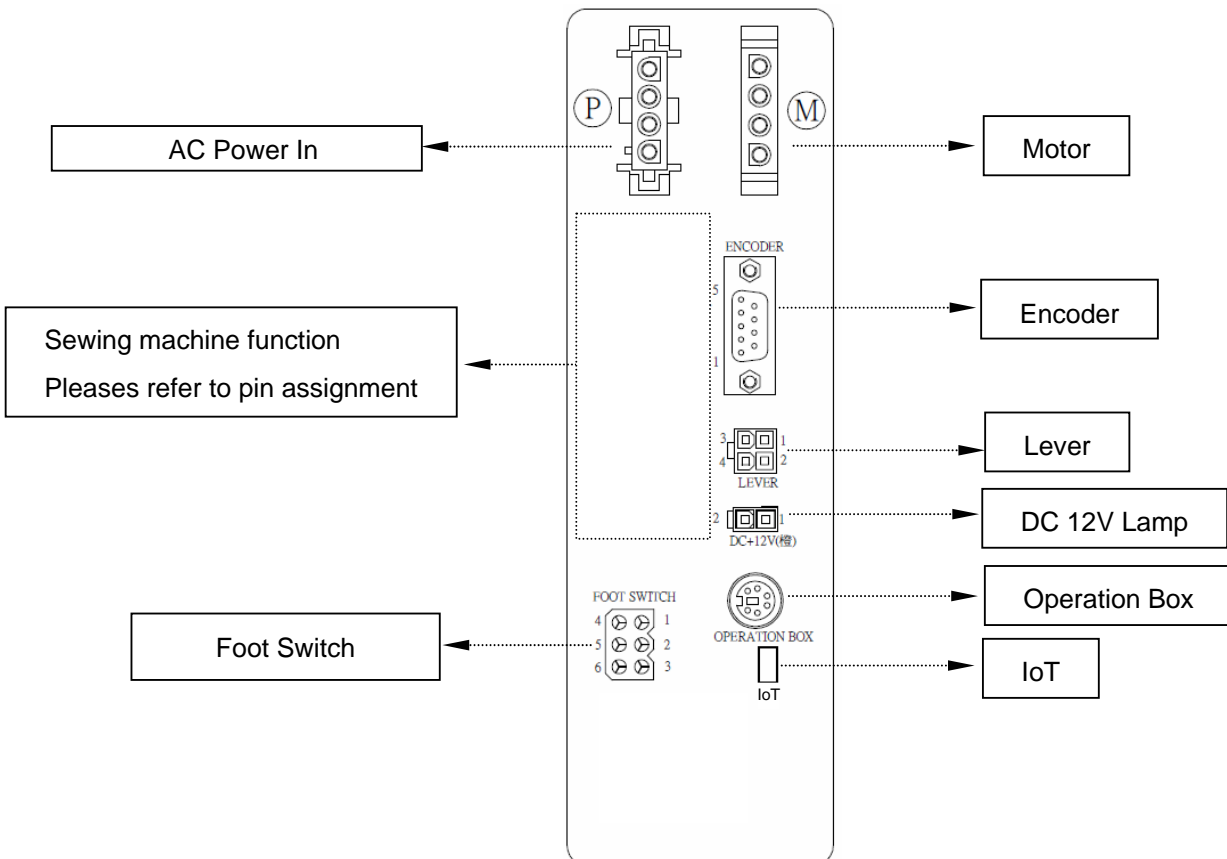

# TD315-6-07-2 端子座圖

## Connector panel diagram

DC+12V LAMP	
1 LED_0V	LED_0V
2 +12V	+12V



SAFETY SW.	
1 +5V	+5V
2 INL	SAFETY SW.
3 0V	0V

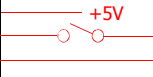

KNEE SW.	
1 INK	KNEE SW.
2 0V	0V

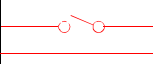

FOOT LIFTER	
1 +24V	+24V
2 OF(8A)	A.F.L. SOL.



SEWING MACHINE	
1 OA(8A)	TRIMMER
2 +24V	+24V
3 +24V	+24V
4 OB(8A)	WIPER
5 OD(1A)	CONDENSED STITCH
6 +24V	+24V
7 OC(8A)	TENSION
8 O1(1A)	OP SOL.
9 +24V	+24V
10 IN1	OP SW.
11 EARTH	EARTH
12 0V	0V

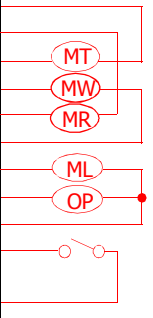

FOOT SWITCH	
1 +12V	+12V
2 ING	START
3 VC	VC1
4 INF	KNEE SW.
5 0V	0V
6 INH	TM SW.

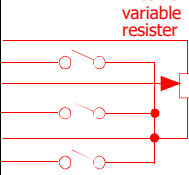

OPTION	
5 O2(1A)	NCL SOL.
10 +24V	+24V
15 O1(1A)	OP SOL.
4 +24V	+24V
9 ---	---
14 +5V	+5V
3 IN2	U SW.
8 ---	PULSE OUT
13 ---	---
2 IN1	OP SW.
7 ---	---
12 0V	0V
1 +12V	+12V
6 INB	PSD
11 0V	0V

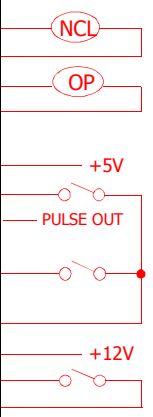
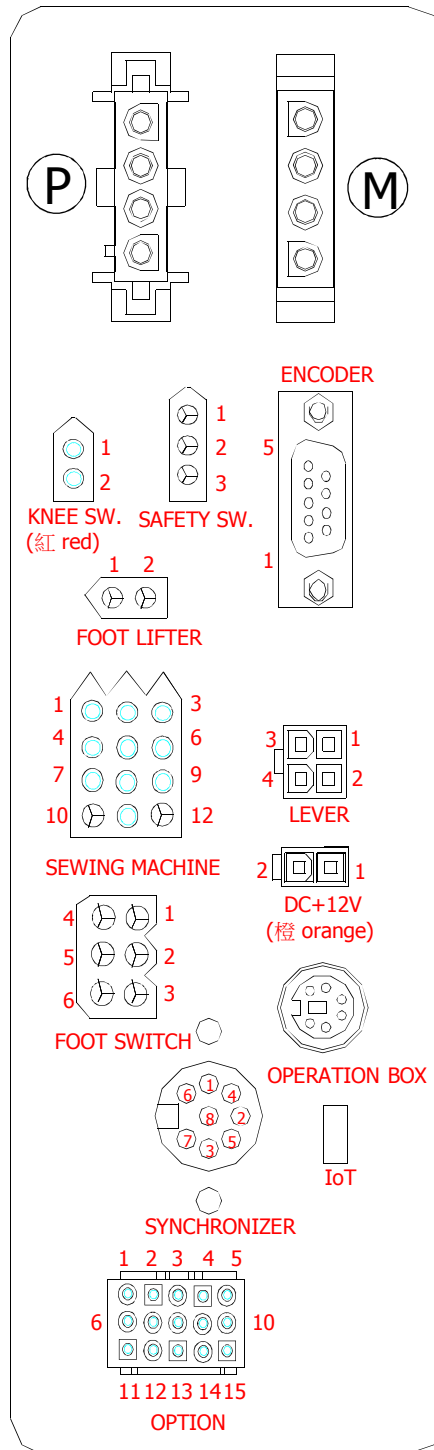
SYNCHRONIZER	
1	---
2	+5V
3	DOWN
4	0V
5	NO SYNC.
6	---
7	UP
8	---

ENCODER	
1	+5V
2	UP
3	DOWN
4	A PHASE
5	B PHASE
6	R
7	S
8	T
9	0V

LEVER	
1	+5V
2	VC
3	KNEE SW.
4	0V

OPERATION BOX	
1	U SW.
2	R1in
3	+12V
4	T1out
5	0V
6	CKU

IoT	
1	+5V
2	T1out
3	R1in
4	---
5	0V







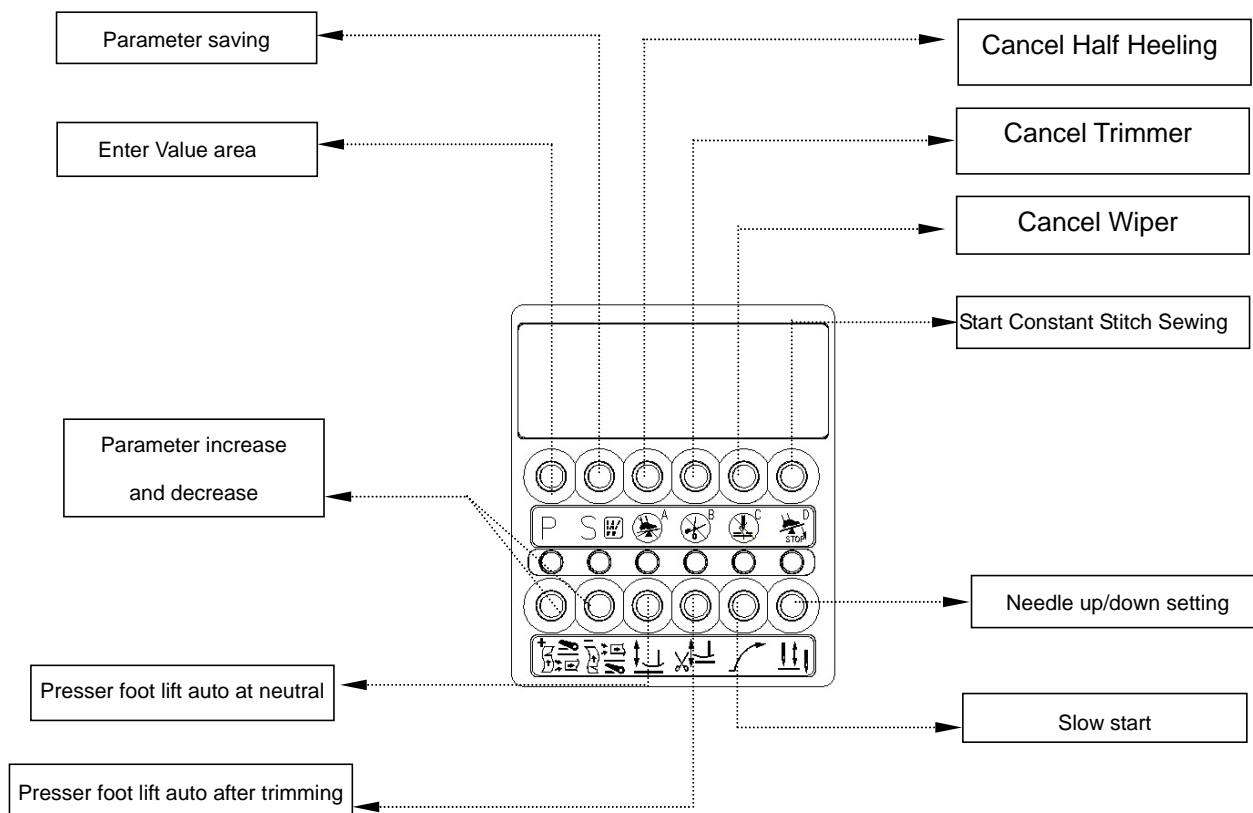

## 5. Programmable 7-segment Display:

(1). Key functions in the **【Normal Mode】** on a interlock stitch machine :



(2). How to access **【Parameter Mode A】** : (Available parameter codes: 1 ~ 46 )

- Under **【Normal mode】** press **P** key will take you into the first parameter code **【001.H】** of **【Mode A】** .
- Press  or  to get the parameter needed. e.g.; **【002.SLM】**
- Press **S** to enter **【parameter value】**
- In this area, press , , , or  key to make value adjustment.
- Press **S** key to save the value.

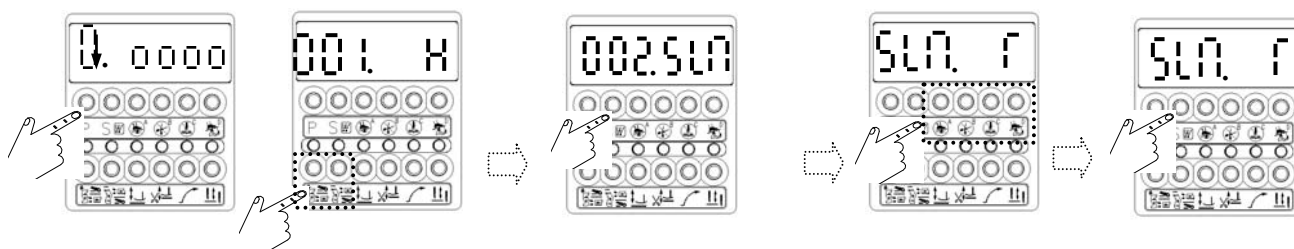

(3). How to access **【Parameter Mode B】** : (Available parameter codes : 1~122)

a. Turn off the power

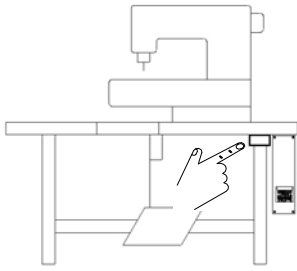

b. Press hold **P** key and turn on the power to access the first parameter code **【047.MAC】** of **【parameter mode B】** .

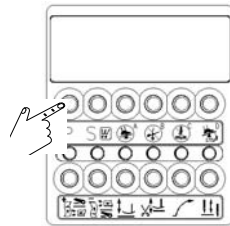

+

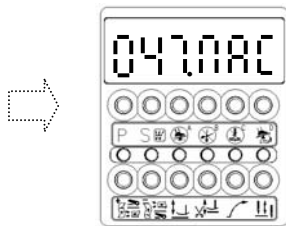
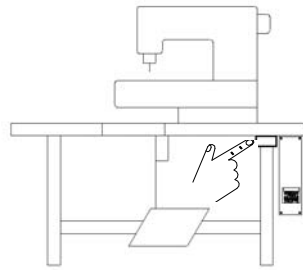

c. Press or key to get the parameter code **【048.N12】**  
 d. Use **S** key to enter **【parameter value】** .

e. In this area press those key <sup>A</sup> <sup>B</sup>  
<sup>C</sup> <sup>D</sup> to make value adjustment.  
 f. Press **S** key to save the value.

Note 1. After pressing **S** key, it will go back to **【Normal Mode】** .  
 Note 2. Example : on Interlock stitch machine.

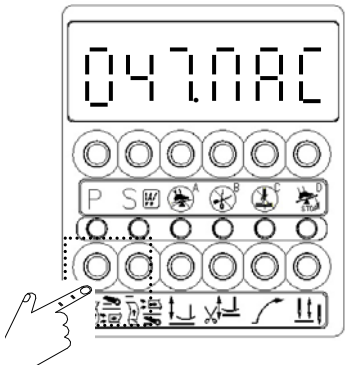

⇒

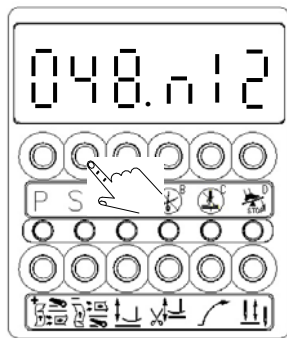

⇒

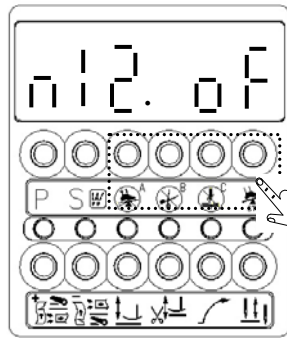

⇒

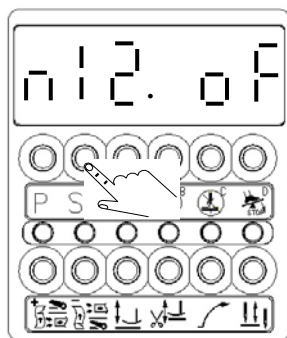

⇒

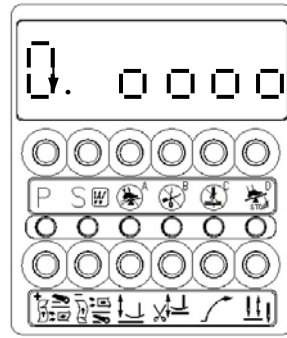

(4). Key functions in the Parameter **【Mode A and B】** : (Example as the following)

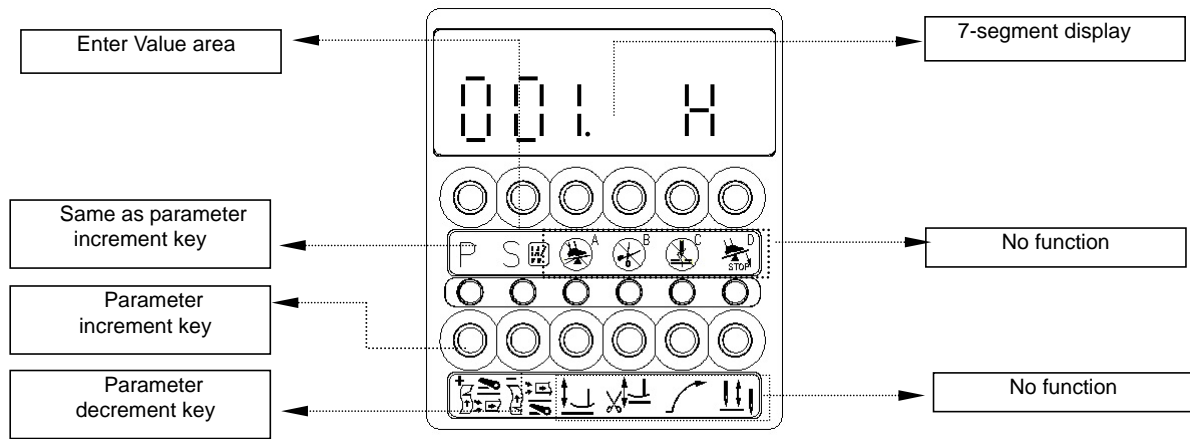

7-segment display { In **【Mode A】** First parameter showing is **【001. H】** All available parameter start 1~46.  
 In **【Mode B】** First parameter showing is **【047.MAC】** All available parameter start 1~122.



(5). How to access the **【Mode Value】** and adjust the setting

Step 1 : Confirm the parameter code you want to make adjust.

(See the parameter table for the detail)

Step 2 : Follow the instruction to access parameter area and call out the parameter code make range.

Speed, timing and angle setting can be set as the following :

Step 3 : Start making adjust parameter value. (Function selection use key  and  to **【001. H】** value setting for your reference)

A). How to increase the default value :

Example Factory default setting **【H.4500】** increase to **【H.5000】** . (See chapter 5, section (4) or (5) to learn how to access a \ b \ c value setting, then do the following step by step.)

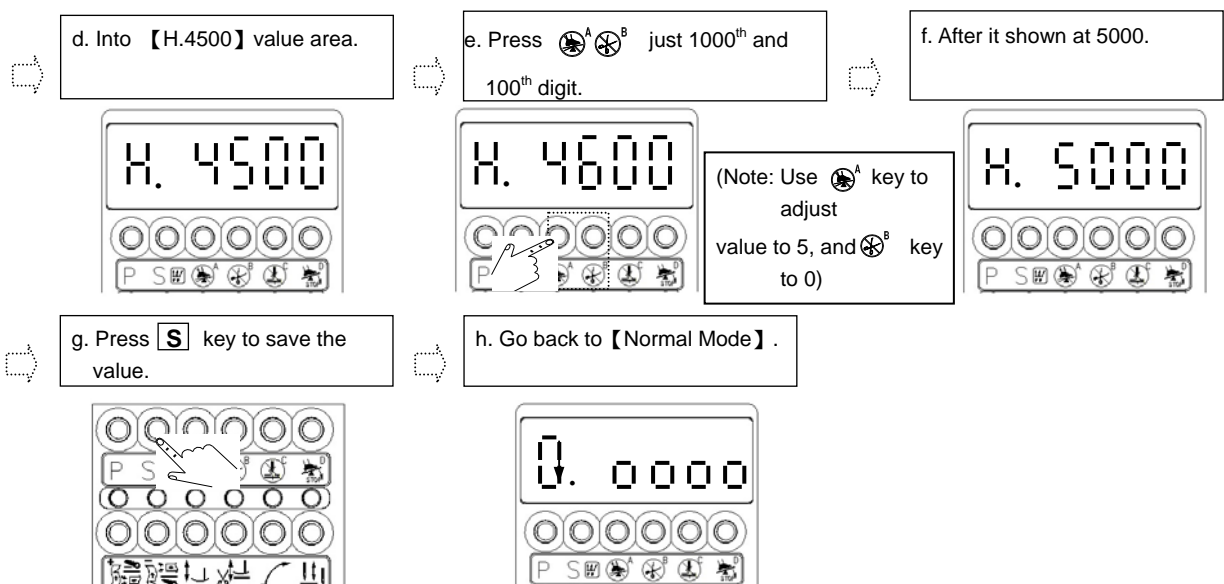

B). How to decrease the parameter value :

Example : Factory default setting **【H. 4500】** decrease to **【H. 4000】** :

(See chapter 5, section (4) or (5) to learn how to access a b value setting, then do the following step by step )



d. Into 【H.4500】 value area.

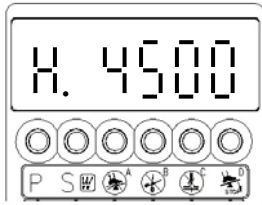

e. Press  to make return at 0.

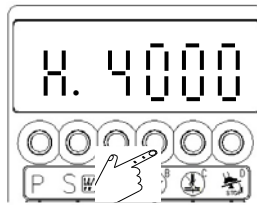

f. After it shown at 4000 or any desire value.

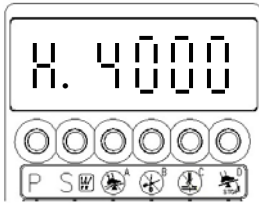

g. Use **S** to save the value.

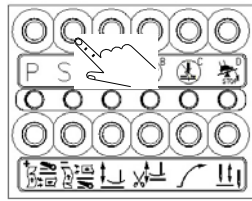

h. Go back to 【Normal Mode】 .

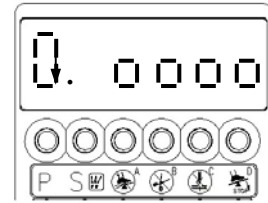











## 6. General Parameter List:

Parameter Code		Parameter Function	Range
Press P Key			
001	H	Maximum sewing speed	50-8000 spm
004	N	Start back-tacking speed	50-8000 spm
005	V	End back-tacking speed	50-8000 spm
006	B	Bar-Tacking Speed	50-8000 spm
007	S	Slow start speed	50-2000 spm
008	SLS	Stitch numbers for Slow start	0-99 stitches
009	A	Automatic constant-stitch sewing speed	50-8000 spm
010	ACD	Automatic sewing End back-tacking	ON/OFF
011	RVM	Back-tacking mode selection	J/B
040	WON	Wiper function selection	ON/OFF
041	TM	Trimmer function selection	ON/OFF
045	SP	Sewing speed	0-8000
046	DIR	Direction of motor rotation	CW/CCW
Press P Key +Power ON			
060	L	Low speed	50-500 spm
061	T	Thread trimming speed	50-500 spm
064	FO	Full-On time setting for foot lifting solenoid	0-990 ms
065	FC	Duty cycle time setting for foot lifting solenoid	10-90%
066	FD	Running-Delay time setting	0-990 ms
070	HHC	Cancel foot lifting at half-heeling pedal	ON/OFF
075	SFM	Safety switch protection mode	NC/NO
083	T2	Trimming time	0-990 ms
087	L2	Timing of tension release	0-1500 ms
093	W2	Setting timing of wiping	0-9990 ms
119	DD	Direct drive or belt drive	ON/OFF
121	ANU	Needle goes up as power turned ON	ON/OFF
122	HL	Upper limit of maximum speed	50-9999 spm

























七段顯示器字體與實際數值對照表：

**7-Segment Display Characters Compare Table**

數值字體部份：（Arabic Numerals）

實際數值 Actual	0	1	2	3	4	5	6	7	8	9
七段顯示器 Display										

英文字體部份：（English Alphabet）

英文數字 (Actual)	A	B	C	D	E	F	G	H	I	J
七段顯示器 (Display)										
英文數字 (Actual)	K	L	M	N	O	P	Q	R	S	T
七段顯示器 (Display)										
英文數字 (Actual)	U	V	W	X	Y	Z				
七段顯示器 (Display)										



高林股份有限公司  
KAULIN MFG. CO., LTD.

由於對產品的改良及更新，本產品使用說明書中與零件圖之產品及外觀的修改恕不事先通知！  
The specification and/or the equipment described in the instruction book and parts list are subject to change because of modification with out previous notice  
C007KD F007KD/CE, C007KD F007KD/CCC.MAY.2022