

SIRUBA

電控參數說明書

ELECTRONIC CONTROL PARAMETER MANUAL

VC008A/B SIMPLE TYPE



歡迎使用本公司產品，制衣行的正確投資選擇！

Welcome to use the our products, it is the right investment choices in garment industry!



安全說明：General SafetyInstructions

1：電機電控接通電源時（開機狀態）請不要把腳放在腳踏板上

Do not put your feet on the pedals when the control box and motor is switched on (boot status)

2：本產品請專業人士安裝調試

Let professionals to install and debug this product

3：嚴禁在通電時打開控制箱與電機端蓋

Do not open the control box and the motor cover when energized

4：換針，穿線或更換底線時請關閉電源

Please turn off the power when changing the needle,threading or replacing the bottom line

5：安裝，拆卸維修時請拔掉電源插頭

During installation and removal service,please turn off the power and pull the plug

6：翻抬縫紉機時請關閉電源

Please turn off the power when turn lift sewing machine

7：使用本產品請遠離高頻電磁波和電波發射器等，以免所產生的電磁波幹擾伺服驅動器而發生錯誤動作。

When use this product, please stay away from high-frequency electromagnetic waves and radio wave transmitters, etc., in case the electromagnetic waves generated interfere with the servo drive to occur wrong action .

鄭重申明：

Solemnly Declare:

1：不遵守安全使用說明操作規章，發生意外後果自負。

Do not comply with the manual book operating regulations and the safety requirements, all accidental occurrence should be taken by yourself.

2：未經本公司授權，請勿擅自改動產品，由此而引起的後果本公司不負任何責任。

Without our authorization, please do not alter our products, our company is not liable for any consequences arising therefrom.

目錄

Content

- 一、產品介紹
Product instructions
- 二、控制台使用說明
Control panel Instruction
- 三、安裝調試：
Installation and trial-run
- 四、電機常用參數設置
Commonly used parameter setting
- 五、一般故障處理
Common faults and treatment
- 六、作業環境要求
Environmental Requirements
- 七、保修服務
Warranty service

一、產品介紹:ProductInstruction

本產品由本公司自主研發,產品個性鮮明,真正體現出了機電一體化的概念,更是節能,高效,環保,優美集結於一身。可廣泛適用於多種縫設備。

WedesighandmanufacturetheservomotorforthepurposeofMechanotronics.

Thismotorfeaturesinenergy-saving,highproductionefficiency,environmentalandcompactCould beusedfordifferentindustrialsewingmachines

1.組成部分:Construction

控制系統由控制器和電機兩部分:

Theservomotoriscomposedofcontrolsystemandmotor

A.控制器:控制箱和腳踏調速器。

A.Controlsystemincludescontrolboxandpedalspeeder

本控制系統體現出了超前的設計理念,系統操作簡單易上手,整個控制系統性能優越。具有起步快,停車快、准等優點。而且電路模組保護功能完善:有欠壓、過流、過壓、掉電等一系列保護功能。踏調速器可實現無級調速。

This control system featuresis easy to use and features in excellent performance, including quick start, quick stop (sewing machine),

accurate needle Position. Furthermore, the modular circuit has Self-

Protection System when against lower voltage,overcurrent,over heatetc. Speed stepless is realized by the pedal speeder.

2. 220V、110V 電機性能參數指標:Specifications

220V 電機性能參數指標 220V Specifications

電源供電電壓 Voltage	220V 單相 1phase
頻率 Frequency	50~60HZ
電機轉速 Speed	200-4500RPM
電機扭矩 Motor torque	≤3.5NM

110V 電機性能參數指標 110V Specifications

電源供電電壓 Voltage	110V 單相 1 phase
頻率 Frequency	50~60HZ
電機轉速 Speed	200-4500RPM
電機扭矩 Motor torque	≤3.5NM

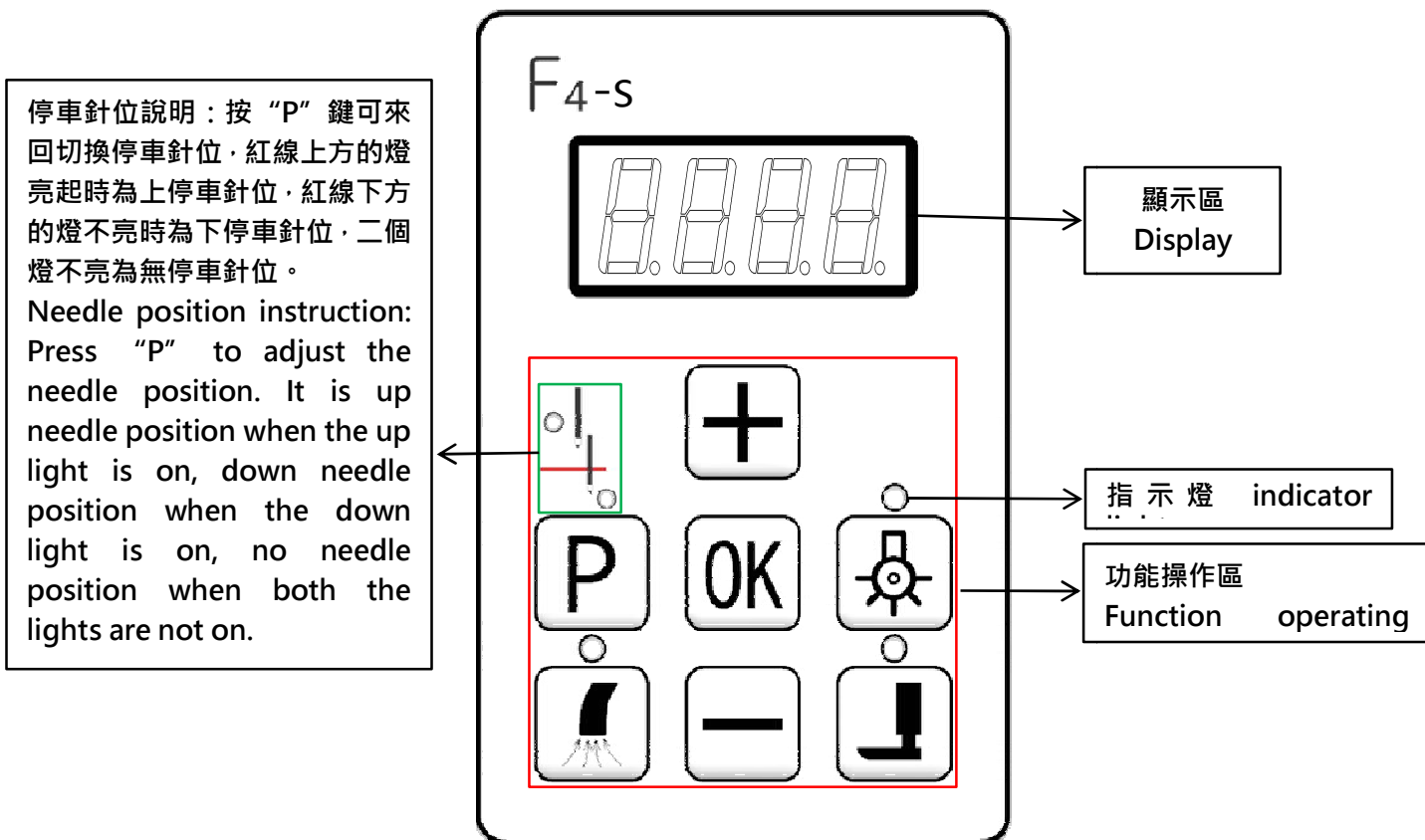

二、控制台使用說明 Control panel Instruction

1、主介面介紹：

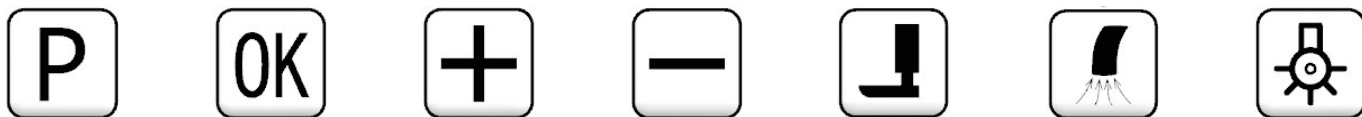

2、功能鍵介紹：



序號 The serial number	按鍵圖示 Parameters of the code	功能說明 function instruction
1	 (菜單鍵) (Menu button)	參數進入 (見進入參數的操作方法) Function Enter button (below to enter the parameter method of operation)
2	 (確認鍵) (Confirm button)	參數確定 Parameter confirm button

3	 (數值調整鍵) (Numerical adjustment key)	向上鍵 (修改資料時加) / (轉速調整加) Up key (when increasing value)
4	 (數值調整鍵) (Numerical adjustment key)	向下鍵 (修改資料時減) / (轉速調整減) Up key (when increasing value)
5	 (壓腳功能鍵) (Presser foot switch)	按一下顯示幕面板上 LED 燈亮起時，自動抬壓腳功能開啟；再按 一下顯示幕面板上 LED 燈不亮時，自動抬壓腳功能關閉。 注：長按  鍵，輸入密碼進入參數修改選項
6	 (吸風功能鍵) (Trimmer switch)	按一下顯示幕面板上 LED 燈亮起時，吸風功能開啟；再按一下顯 示幕面板上 LED 燈不亮時，吸風功能關閉。 注：長按  鍵，輸入密碼進入參數修改選項
7	 (機頭燈調整鍵) (Machine LED button)	按一下  鍵，LED 燈亮起時，機頭燈功能開啟；再按一下顯示 幕面板上 LED 燈不亮時，機頭燈功能關閉。

3、埠說明

吸風、抬壓腳介面 Suction plug

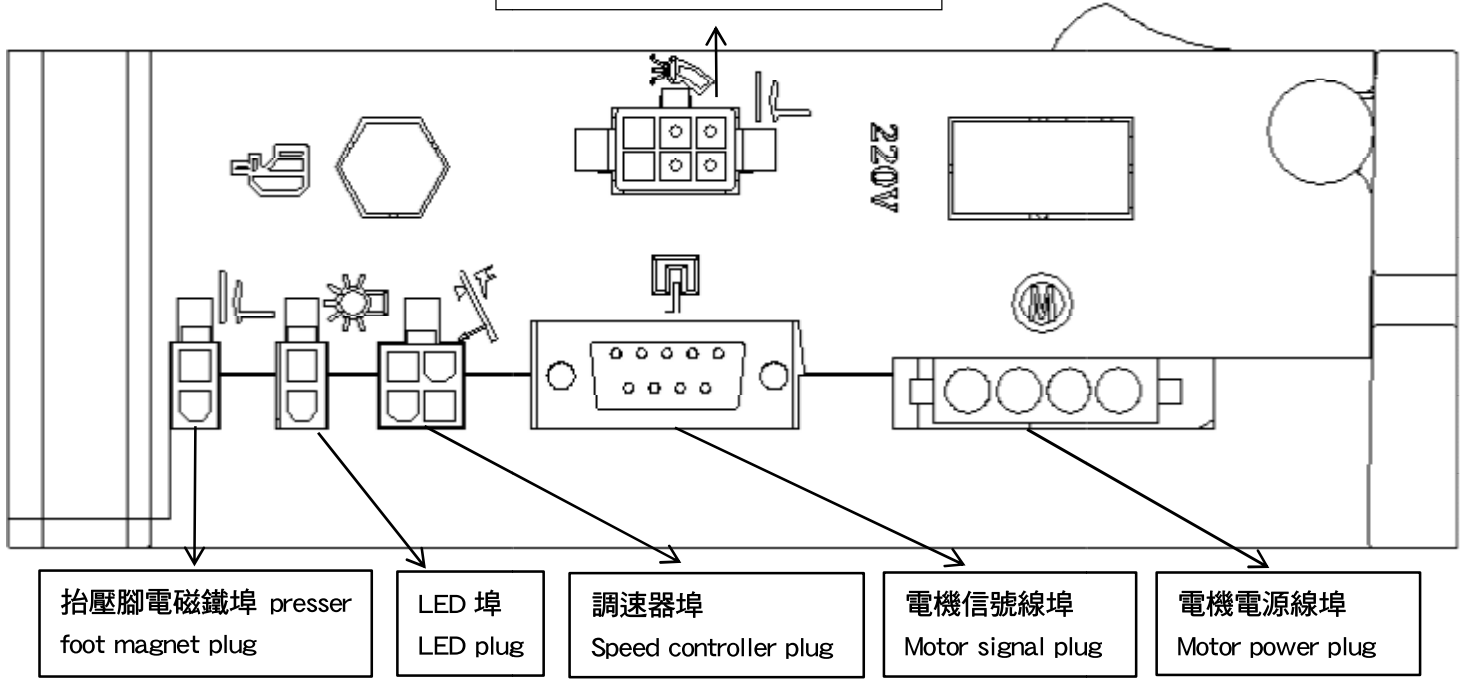

序號	埠	注明
1		1 3
		地 G 輸出 OUT
		2 4
		無 正 +
3		1 2
		24V 負 -

序號	埠	注明
2		1 2
		負 - 5V
4		1 4
		24V 負 -
		2 5
		24V 負 -
		3 6
無 無		

4、進入參數的操作方法:Method of operation of entry parameter:

例:怎樣把電機的順時針轉調到逆時針轉

For example: how to adjust the motor from clockwise to counterclockwise

A.先打打開電源,

B.先按 " " 鍵不放,再用另一隻手按 " " 號鍵,此時畫面會顯示 P-00,

C.此時按 " " 號鍵,畫面會顯示 P-02,(P-02)就是電機正反轉參數(常用參數表上有)。

D.此時按 " " 鍵畫面會顯示 "1"

E.此時按 " " 號鍵把 "1" 調到 "0" ("1" 為順時針轉, "0" 為逆時針轉,常用參數表上有)。

F.按 " " 鍵確定參數調整完畢並退出參數。

A.first open the motor,

B. Press do not release, use another hand to press , at this time the screen shows P-00,

C.then press button, the screen occur P-02, (P-02) is the motor direction parameter.

D.this time press , the screen shows "1"

E. This time press to change "1" to "0" ("1" is clockwise, "0" is counterclockwise)

F. Press to confirm the parameter adjustment is finish and exit the parameter.

5、恢復出廠設置:Restore factory settings

先按 " " 鍵不放,再用另一隻手按 " " 號鍵、此時畫面會顯示 P-00,再長按 " " 鍵約

3 秒即可,(恢復出廠設置值在常用參數表裡)。

Restorefactorysettings:Pressthe key,noleave,andusetheotherhand press the "

"key,thescreenwilldisplaythep-00,then press " " keyseconds,itwillRestorefactorysettings.

三、安裝調試：Installation and trial-run

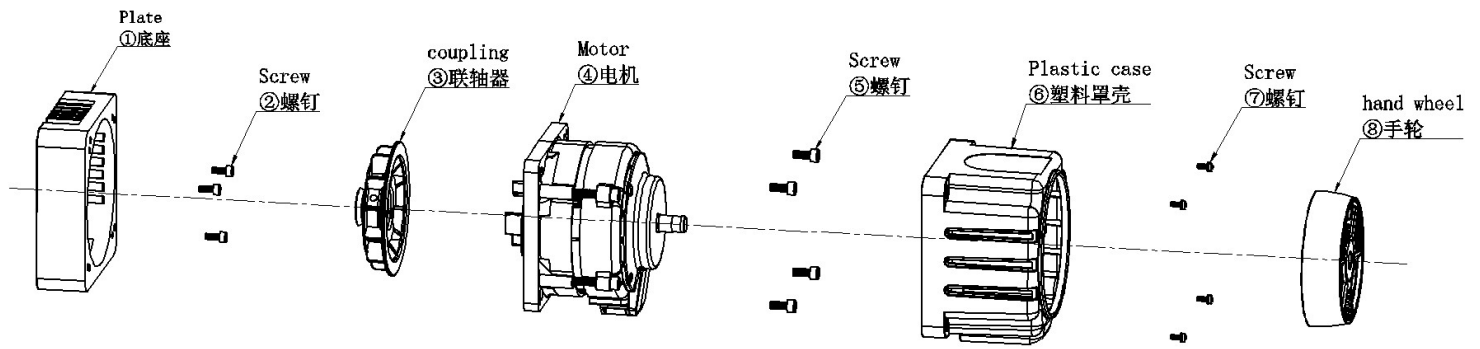

(1) 安裝底座：將安裝示意圖中的圖①底座對準機器，用圖②螺絲固定。

(2) 安裝聯軸器：將圖③聯軸器套入機器主軸，擰緊聯軸器上的固定內六角螺絲

(3) 安裝電機：將電機上的軟連接安裝至聯軸器上，用圖⑤螺絲固定電機。

(4) 安裝罩殼：套入電機塑膠罩殼，用圖⑦螺絲固定。

(5) 安裝手輪：將手輪套入電機軸，手輪上的停針指示對準電機罩殼標記(如圖⑨)，手輪與電機間距 1.5mm，固定手輪內六角螺絲。

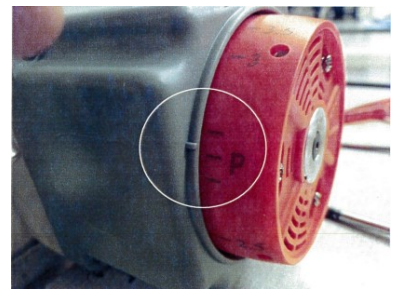

圖⑨

(1) Plate installing: install the plate (①in the installation diagram) to the machine, fix it with the screws(2 in the installation diagram).

(2) Coupling installing: set the coupling onto the principal axis, fix it with tightening the hexagon socket screws.

(3) Motor installing: fix the flexible coupling to the coupling, fix it with the screws (⑤in the installation diagram).

(4) Case installing: set the motor plastic case onto the motor, fix it with the screws (⑦in the installation diagram).

(5) Hand wheel installing: install the hand wheel onto the shaft, justify the needle position mark to the case (as ⑨), set the distance less than 1.5mm, fix it with the hexagon socket screws.

三、電機常用參數設置: Commonly used parameter setting

序號 The serial number	參數編號 Parameters of the code	參數名稱 The parameter name	參數範圍 Adjusting range		出廠設置 The factory Settings	備註 Other
1	P-01	最大速 Maximum peed lock	200-4000RPM		3500 轉	
2	P-02	電機方向 Direction of rotation	0 是逆針轉 0 is counter clockwise	1 是順針轉 "1" is clockwise turn	1	
3	P-03	下停角 The needle Angle	6-18 度		12 度	
4	P-04	起縫速度 Start sewing speed	200-800 轉		250 轉	
6	P-06	定針縫 Set the seam	0-999 針		0	
7	P-07	空				
8	P-08	空				
9	P-09	空				
10	P-10	自動間隙運行(跑合) Automatic clearance run(run)	把 0 把改成 1 再按 S 鍵 Then press the S key change to 1		0	關掉電源停止跑合 Turn off the electricity stopped running
11	P-11	抬壓腳起動時間 Presser foot ascend starting time	0-2000ms		0	
12	P-12	-----	-----		-----	-----
13	P-14	最大電流限制 Maximum current limiting	50-1000		260	
15	P-15	是否檢測上針位 Whether to detect the up needle position	1:檢測針位, 0:不檢測 1:detecting needle 0:no detection		1	設為 1 時, 如果無上定位感測器則報警 ER01, 設為 0 時則不報警 Set "1", if there is no upper needle stop sensor will alarm ER01; set "0" no alarm
16	P-17	重定出廠密碼 factory reset code	1-3		1	P-09 參數開啟後才能出現 P-17 參數、設為 3 長按 OK 鍵恢復出廠密碼 when open the parameter "P09", then it can occur "P17", set "3", then long press "OK" button to recover the factory code
17	P-18	出廠密碼 factory code	0000-9999		2013	

18	P-19	軟起動針數 soft start stitches	0-15	0	0 針關閉該功能，1-15 針時啟用軟啟動，並設定針數（上停針時有效） 0 stitch is close this function, 1-15stitches is open the soft start , and set the stitches(upper needle position is effective)
19	P-20	軟起動速度 soft start speed	200-3500	800	
20	P-21	吸氣功能 suction function	0:關閉 1:開啟 0: close 1:start	1	電機運轉時開啟/關閉吸氣功能 motor running open/close suction function
21	P-22	吸氣開啟針數 suction start stitches	1-200	30	吸氣打開針數（P23 針數打開時有效） suction open stitches(P23 stitches open have effective)
22	P-23	吸氣關閉針數 suction close stitches	0-200	0	
23	P-24	吸氣動作維持時間 suction action maintain time	50-2000ms	120ms	此參數暫時不用 this parameter do not use now
24	P-25	吸氣全功率時間 suction full power time	35-1000ms	120ms	
25	P-26	吸氣全功率時功率 the power of suction full power	5-100%	100%	
26	P-27	吸氣維持功率 suction maintain power	1-100%	80%	
27	P-28	吸氣釋放時間 suction release time	0-500ms	20ms	
28	P-29	吸氣保護時間 suction protection time	1-120s	30s	吸氣單次動作最長時間 the longest time of suction single action
29	P-30	壓腳觸發模式 foot presser trigger mode	0:關閉 1:開啟 0: close 1:start	0	1. 設為 0 時，後踏速控器壓腳不抬。設為 1 時後踏速控器壓腳抬起， 2. 維持抬起，直到前踏或保護時間到才會釋放壓腳，並且每次電機停止時自動抬壓腳 1, set "0" , back step the pedal,the foot presser is not up, set "1" , back step the pedal, the foot presser is up. 2, the foot presser is maintain up, until front step the pedal or the protection time is finish then release, and motor stop, the foot presser is up automatic.

30	P-31	後抬腳啟動時間 back foot presser lifter start time	0-2000ms	0	後踏延遲啟動壓腳的時間 the time of back step delay start foot presser
31	P-32	抬壓腳動作維持時間 foot presser lifter action maintain time	50-1000ms	160ms	此參數暫時不用 this parameter do not use now
32	P-33	抬壓腳全力功率時間 foot presser lifter full power time	35-1000ms	160ms	
33	P-34	抬壓腳全力功率時功率 the power when the foot presser lifter full power	5-100%	100%	
34	P-35	抬壓腳維持功率 foot presser lifter maintain power	1-500%	80%	
35	P-36	抬壓腳釋放時間 foot presser lifter release time	0-120ms	30ms	壓腳釋放時間 the foot presser lifter release time
36	P-37	抬壓腳保護時間 foot presser lifter protection time	1-100s	10s	壓腳單次抬起最大維持時間 the biggest maintain time of the foot presser lifter single time
37	P-38	顯示速度 display time	200-6500RPM		顯示當前電機實際速度 display the current motor real speed
38	P-39	顯示速控器電壓 display the volt of speed controller	14-1010	中點電壓 195 Neutral point volt	顯示當前速控器電壓 0—1024，相當於 0-5V Display the current speed controller volt 0-1024, it is equal 0-5V
39	P-40	顯示直流母線電壓 display DC buses voltage	60-500V	310v	當電壓高於 395 會報警，(直流母線電壓/1.414=交流母線電壓)when the volt is higher than 395V will alarm,(DC buses volt/1.414 = AC buses volt)
40	P-41	過壓保護開關 overload protection switch	0:關閉 1:開啟 0: close 1:start	1	設為 0 關閉過壓報警，設為 1 打開報警，當直流母線電壓超過 395V 時，報警 Er16，電機自動停止運行，報警後當電壓低於 385v 電機可再次運行 set "0" is close the overload alarm, set "1" is open the alarm, when DC buses voltage is over 395 V , will display Er16, the motor will stop automatic, when volt is lower 385V, the motor can run.
41	P-42	掉電檢測	0-3	2	0:都關閉；1：開機檢查調速器是否復位；2：掉電檢測使能；3：都使能

四、一般故障處理:Common faults and treatments

序號 The serial number	錯誤碼 Error code	錯誤內容 Error content	錯誤問題的多種可能 Several possible error problem
1	Er01:	找不到停車位 No stop signal	1.定位器信號插頭未插好 2.定位器感應位置靠近一點與磁鋼(1mm-15mm)距離 1. locator signal plugs not inserted 2.the locator induction position close to the point keep 1mm-1.5mm distance and magnetic steel
2	Er02:	開機沒有檢到調速器 Not find the speed controller	1.調速器插頭沒有插 2.調速器線斷了 1.Speed control device plug is not insert. 2.Speed controller wire is broken
3	Er03:	電機霍兒或相位線錯誤 Motor Hall or phase error	1. 九針插頭接觸不良： 2. 電機沒有安裝好： 3.霍兒壞：1.The motor doesnt install good 2.Nine hole plug contact undesirable 3.Hall bad
4	Er04:	堵轉保護 Lacked-rotor protection	1.電機超載 2.電機與電控根連接的四心線接觸不好 1.The motor overload 2.The motor and the controller connected four hole line contact is not good
5	Er05:	硬體過流保護 Hardware over-current Protection	1.電機超載 2.信號線接觸不好或斷了 1.The motor overload 2.Signal wire not good or broken
6	Er07:	串口通信時錯誤 Serial per communication	顯示幕至主機板信號線不良或主機板壞 Display to the system board signal bad or bad

五、作業環境要求：Environmental Requirements

1.請不要在過潮濕環境中作作業

Please do not work at damp place

2.220V 電控：【220V 接入供電時電壓穩定在 (AC200V ~ 260V/單相) 之間】

220V electronic control: [220V access to power supply voltage stability between (200V~260V)]

110V 電控：【110V 接入供電時電壓穩定在 (AC100V ~ 130V/單相) 之間】

110V electronic control: [110V access to power supply voltage stability between (100V~130V)]

3.用戶使用前必須接地,確保人身安全

Must be adequately grounded for safety

4.不要在過熱地方作業

Do not work at high temperature

5.控制系統與電機不要在強磁高輻射環境中作業,以免干擾而使系統錯誤

Do not run motor and control system near to ferromagnetic or high-radiance area

六、保修服務:warranty Service

1.本產品自購買起免費保修 1 年,終身維護。保修期內除人為損壞以外出現任何品質問題可免費維修。

Our products come with year of quality guarantee,from the ship day.Within guarantee period, service is free of charge, unless man-made damage or misuse

2.在保修期內,以下情況出現損壞本公司不給於保修服務。

During the guarantee period, our free service does not cover below:

(1).未經本公司同意自行拆卸,修理,改裝造成的故障或損壞。

Dismantle the motor unit without permission, and cause damage.

3.但凡出現無法解決的問題可以聯繫本公司。

please contact us whenever have problem.



高林股份有限公司
KAULIN MFG. CO., LTD.

由於對產品的改良及更新，本產品使用說明書中與零件圖之產品及外觀的修改恕不事先通知！
The specification and/or the equipment described in the instruction book and parts list
are subject to change because of modification with out previous notice
VC008A/B.JUL.2022